

**SPECIFICATION FOR THE  
CONSTRUCTION OF A WASTEWATER  
PUMPING STATION  
TO SERVICE A DEVELOPMENT FROM 2 TO 500  
PROPERTIES  
FOR  
ADOPTION BY NORTHERN IRELAND WATER**

**Please note that when submitting a new Article 161 application that incorporates a Wastewater Pumping Station you must download this specification to ensure that your proposal is designed to the current specification.**



## FOREWORD

This standard specification for a Wastewater Pumping Station can service a development from 2 to 500 properties and has been prepared by Northern Ireland Water's Developer Services Team, and Wastewater Asset Performance M&E.

The specification is primarily for use by developers who are required to construct a Wastewater Pumping Station in association with and to service all or part of the drainage layout being considered for Article 161 Approval, under the Water and Sewerage Services (Northern Ireland) Order 2006 (as amended Water and Sewerage Services Act (Northern Ireland) 2016) for new developments.

### Please note

- the use of a Pumping Station will only be considered if no practical gravity solution is applicable.
- This Specification covers the civil and M & E requirements for Wastewater Pumping Stations serving from 2 to, 500 properties

Any queries relating to this document should be directed to the appropriate Developer Services Regional Team. If you are unsure who to direct your enquiry to please email the Customer Engagement Team and they will be happy to direct your enquiry to the appropriate person.

Contact address:

**Customer Engagement Team  
Northern Ireland Water**

**Email:** [CustomerEngagementTeam@niwater.com](mailto:CustomerEngagementTeam@niwater.com)  
**Tel:** 03458 770 003

**Document Control Information**

Ver No	Date	Purpose of Issue	Reviewed	Checked	Authorised for Issue
Jan 2025	Nov 2024	Jan 2025 Revision	ST	JR	

Ver No	Summary of key changes	Reason
1.0	Recorded through tracked changes	Ongoing doc development

Main Contributors	Initials	Role
David Rankin	DR	Operations Technical Support Manager
Jonathan Russell	JR	Developer Services Adoptions Manager
Mark Nelson	MN	Operations Technical Support Engineer
Christpher Cole	CC	Operations Technical Support Engineer
Sean Brown	SB	Wastewater Approvals Technical Advisor
Susan Taylor	ST	Wastewater Approvals Lead

Main Reviewers	Initials	Role
John Bell	JB	
Gavin McCready	GMcC	

**PLEASE DESTROY ALL SUPERSEDED COPIES OR CLEARLY MARK THEM AS “SUPERSEDED”.**

# Table of Contents

<b>Document Control Information</b> .....	<b>3</b>
<b>HEALTH AND SAFETY</b> .....	<b>6</b>
<b>INFORMATION TO BE SUBMITTED</b> .....	<b>6</b>
<b>SECTION 1 - CIVIL SPECIFICATION</b> .....	<b>8</b>
1.0    GENERAL .....	8
2.0    PLANNING AND OTHER CONSENTS .....	8
3.0    ROAD OPENING (Street Works Licence).....	8
4.0    LOCATION .....	8
5.0    SITE .....	8
6.0    SITE WORKS / ACCESS ROAD .....	9
7.0    BOUNDARY DEMARCATION .....	9
8.0    WATER/ ELECTRICITY SUPPLY .....	9
9.0    WET WELLS .....	9
10.0   ACCESS COVERS AND FRAMES .....	10
11.0   LADDER .....	11
12.0   VENTILATION .....	11
13.0   ODOUR MANAGEMENT .....	11
14.0   PIPEWORK .....	11
15.0   VALVE CHAMBER AND VALVES .....	11
16.0   FLOW METER CHAMBER.....	12
17.0   PUMPING MAIN – BLACK .....	12
18.0   ADOPTION.....	12
19.0   BOND SURETY / RECHARGEABLE.....	13
20.0   MAINTENANCE .....	13
21.0   ELECTRICITY METER INSTALLATION/ELECTRICAL COSTS .....	13
22.0   ELECTRONIC DETAILS AND INFORMATION.....	13
<b>SECTION 2 - M &amp; E SPECIFICATION FOR WASTEWATER PUMPING STATIONS</b> .....	<b>14</b>
<b>PART A - M &amp; E SPECIFICATIONS FOR WASTEWATER PUMPING STATIONS– PUMP SPECIFICATION</b> .....	<b>14</b>
23.0   INTRODUCTION .....	14
24.0   PERFORMANCE REQUIREMENTS AND INFORMATION .....	14
25.0   DESIGN REQUIREMENTS .....	14
26.0   Pump set PROTECTION SENSORS .....	17
27.0   TESTING .....	17
<b>PART B – MOTOR SPECIFICATION</b> .....	<b>18</b>
28.0   INTRODUCTION .....	18
29.0   PERFORMANCE REQUIREMENTS .....	18
30.0   DESIGN REQUIREMENTS .....	18
<b>PART C – ELECTRICAL SPECIFICATION</b> .....	<b>19</b>
31.0   SCOPE .....	19
33.0   SUPERSTRUCTURE/ELECTRICAL EQUIPMENT KIOSK.....	20
34.0   CONTROL PANEL.....	21
35.0   ELECTRICAL INSTALLATION.....	23

<b>PART D –VALVE SPECIFICATION</b> .....	<b>26</b>
36.0 Introduction.....	26
37.0 Gate (Sluice) Valves .....	26
38.0 Check (Reflux) Valves .....	26
39.0 Maintenance/Operational Issues .....	26
40.0 Miscellaneous .....	26
<b>PART E - TELEMETRY SPECIFICATION</b> .....	<b>27</b>
41.0 Telemetry Installation & Configuration .....	27
42.0 General .....	27
43.0 Selection of Communications Modem.....	27
44.0 Telemetry Outstation .....	27
45.0 Telemetry Configuration .....	28
46.0 Telemetry Digital Radio .....	28
47.0 Telemetry Aerial Pole .....	28
48.0 Telemetry Aerial .....	28
49.0 Commissioning of Telemetry System.....	28
<b>PART Of ASSET DATA CAPTURE (BUDIReturn)</b> .....	<b>29</b>
<b>APPENDIX A - NIW SITE SIGNAGE REQUIREMENTS</b> .....	<b>30</b>
<b>APPENDIX B</b> .....	<b>32</b>
NIW WWPS 01 Typical arrangements of WWPS.....	32
NIW WWPS 02 Typical Site Layout (including Permitted distance from circumference of any chamber designed to contain sewerage and / or odour emitting equipment to the nearest habitable property (existing / proposed)) .....	33
NIW WWPS 03 Standard Flush Mount Davit Socket.....	34
<b>APPENDIX C</b> .....	<b>35</b>
NIW WWPS 04 NIW Typical Standard Panel Layout .....	35
NIW WWPS 05 NIW Typical Standard Panel Control Section .....	36
NIW WWPS 06 NIW Typical Standard Panel Mains Section .....	37
NIW WWPS 07 NIW Typical Standard Panel - Starter Section Grundfos ASD .....	38
NIW WWPS 08 NIW Typical Standard Panel - Starter Section Grundfos DOL.....	39
NIW WWPS 09 NIW Typical Standard Panel - Starter Section Xylem ASD .....	40
NIW WWPS 10 NIW Typical Standard Panel - Starter Section Xylem DOL.....	41
NIW WWPS 11 Pumping Station Kiosk Detail DRP 1000a .....	42

## HEALTH AND SAFETY

All Wastewater Pumping Stations, as well as sewerage systems, shall comply with the Health and Safety at Work (NI) Order 1978, and all statutory rules and regulations in force at the time of submission for adoption approval including where applicable the Construction (Design and Management) Regulations (NI) 2015.

- Health and Safety signage at site, kiosk and panel are the responsibility of the Developer as soon as the WwPS becomes operational.
- General site identification to be provided by the Developer and **only to be fitted on the day of Adoption Handover**. The details to be included on the site signage in advance of the Adoption Handover are in Appendix A.
- Developer is responsible for all Operational, Environmental and Health & Safety compliance during construction and until Final Adoption has been authorised.

## INFORMATION TO BE SUBMITTED

Before any equipment is ordered or supplied the following information shall be submitted to and agreed with NI Water and must be site specific:

- a. Detailed drawings of the proposed wastewater pumping station must include the following:
  - (i) detailed site layout scale 1:20 (Construction details of the wastewater pumping station, valve chamber, flow meter chamber, overflow termination structure (if applicable), incoming sewers and manholes, pumped main and lighting etc.) inclusive of the 12-figure grid reference indicating the centre of the proposed wastewater pumping station site for telemetry path profiling.
  - (ii) Overall layout of the pumping main from the WwPS to discharge location showing for example hatch boxes, Inspection boxes or air valves.
  - (iii) inlet pipework to include levels to Ordnance Datum (Belfast).
  - (iv) detailed wet well design (plan & sections) to include levels to Ordnance Datum (Belfast).
  - (v) Drawing clearly showing the 17m odour zone
  - (vi) Auto tracking to accommodate a lorry mounted vacuum tanker (up to 32 tonne G.V.W).
  - (vii) pumping main diameter, chainage, and discharge level.
  - (viii) benching details supplied by pump manufacturer to be supplied with drawings.
  - (ix) emergency storage and overflow arrangement including screening.
  - (x) emergency overflow discharge point (NIEA approved).
  - (xi) location of all existing underground and overhead services should be shown on the drawings.  
1:500:Horizontal, 1:100:Vertical : Longitudinal sections of the rising main and discharge detail and overflow pipework showing existing and proposed levels, pipe material, diameters, and bedding classifications.
  - (xii) written confirmation from Rivers Agency whether the proposed wastewater pumping station is located within a Flood plain.
- b. M & E specification including the following:
  - (i) quantity, head, power, and system performance curves for the pumping sets.
  - (ii) control panel wiring diagrams for approval.
  - (iii) detailed kiosk drawings.
  - (iv) general M & E Equipment.
- c. Confirmation from the electricity service provider of suitability to supply the wastewater pumping station requirements.
- d. Approval to discharge the emergency overflow to a suitable watercourse must be obtained from Rivers Agency and Northern Ireland Environment Agency. This approval should include the required storage capacity as stipulated by Northern Ireland Environment Agency.
- e. If NIEA stipulate that there is no discharge location for an emergency overflow, the NIEA document should be submitted when making the Article 161 application and the formula in Table 1 should be used to calculate volume of emergency storage.

**Table 1**

Dry Weather Flow ( <b>DWF</b> ) (m <sup>3</sup> /day)	PG + I + E
Flow to Full Treatment: <b>FFT</b> (m <sup>3</sup> /day)	3PG + I + 3E
P - Population served by a separate sewerage system = No. of properties times Occupancy (3.5 persons per property) G - Daily water Consumption (145 litres / head / day) I - Infiltration (40 litres/head/day) E - Trade Effluent (head / day)	

Where NIEA stipulate that there is no emergency overflow outlet, emergency storage shall be 4 hours @ **FFT**

- f. Names and Addresses of manufacturers of various items of proposed plant and spares.
- g. Description literature and materials specification for pumping equipment.
- h. The developer will have to provide a copy of an asbestos survey covering the site to be adopted if it has been identified at Planning stage that there is a risk of Asbestos contamination. Advice available from <http://www.hse.gov.uk/asbestos/surveys.htm> (to be included within the O&M Manual)
- i. The developer must provide a Fire Risk Assessment for the site to be adopted. Advice available from <http://www.nifrs.org/firesafe/guidance.php>

# SECTION 1 - CIVIL SPECIFICATION

## 1.0 GENERAL

- 1.1 Any construction or procurement of materials prior to the NI Water authorisation will be at the Developer's risk.
- 1.2 The design proposals and drawings for the proposed Wastewater Pumping Station and associated chambers, pipework etc. shall be submitted as part of the Article 161 application via the NI Water Self Service Portal.
- 1.3 The layout and construction of the proposed Wastewater Pumping Station and line and level of the pumping main shall conform in all respects to the drawings submitted to and approved by the Developer Services Manager, NI Water.
- 1.4 The Wastewater Pumping Station design approval will form part of the overall Article 161 Agreement for the development.
  - 1.4.1 The sewerage system draining to the Wastewater Pumping Station will not be adopted until such times as the Wastewater Pumping Station final adoption has been satisfactorily completed.
  - 1.4.2 The Wastewater Pumping Station adoption will not take place until the land has been transferred and vested in NI Water ownership.
  - 1.4.3 Connections to the public sewer network directly or indirectly will be deemed illegal if an Agreement to Adopt is not in place.

## 2.0 PLANNING AND OTHER CONSENTS

- 2.1 The developer should liaise with all necessary public bodies and utility companies, obtain the required consents applicable to the construction of a wastewater pumping station, pumping main and emergency overflow. Generally, the bodies concerned are:  
Northern Ireland Environment Agency, DfI Rivers, DfI Roads, local Building Control, Electricity Service Provider, piped gas companies and telephone and cable television companies.

## 3.0 ROAD OPENING (Street Works Licence)

- 3.1 Permission must be obtained from DfI Roads before any opening is made in a public carriageway. Written evidence of valid Street Works Licence to be provided where appropriate.

## 4.0 LOCATION

- 4.1 The minimum distance from the wet well of the wastewater pumping station to any habitable buildings should be in accordance with Table 2, to minimise the risk of odour, noise and nuisance. This dimension may be subject to change depending on the local circumstances and submission of a Development Encroachment – Odour Assessment (DEOM).

**Table 2**

No of properties	Permitted distance from circumference of any chamber designed to contain sewerage and / or odour emitting equipment to the nearest habitable property (existing / proposed)
2 - 500	17 m

- 4.2 The environmental impact of Wastewater Pumping Stations, particularly noise and odour nuisance should be considered. This will be an issue at the planning stage. ***Due care should be exercised in the location of the pumping main discharge point. Every effort should be made to ensure that discharge occurs remote from housing.***
- 4.3 The location of all wastewater pumping stations should be such as to permit vehicular access for the purpose of repair and maintenance. The access road and turning area should be sufficient to accommodate a lorry mounted vacuum tanker (up to 32 tonne G.V.W).
- 4.4 The wastewater pumping station must be constructed above any potential flood plain and to ensure there is no out of sewer flooding in a 1 in 30 years storm and no localised flooding in 1 in 100 years storm. Electrical Control Panels to be located above the 1 in 200-year flood plain
- 4.5 Before the location of wastewater pumping stations are decided the electricity service provider must be consulted as to the availability of providing the requisite power supply. A NIE Meter Point to be located within the MCC Kiosk.
- 4.6 Developer is to provide ground investigation data including data of the wastewater pumping station compound to determine underlying ground conditions for suitability and presence of water table. This may result in flotation calculations being required.

## 5.0 SITE

- 5.1 The agreed site for the wastewater pumping station together with vehicular access thereto shall be transferred to NI Water, free of all charges, at the expense of the developer prior to the Handover Adoption with NI Water.
- 5.2 All elements of the pumping station must be enclosed within the wastewater pumping station fenced boundary and sized accordingly to allow safe operations and access to all areas within the compound.



- 5.3 Future site maintenance should be kept to a minimum, site surfaces should be reinforced concrete, 150mm in depth, within the entire compound. A raised Pin Kerb (100mm min.) or similar is required around the fence line of the compound perimeter with a drainage channel, D400 rated, across the gate.
- 5.4 Gullies within the compound and the drainage channel across the gate shall be trapped and drain to the pump wet well. The gully and drainage channel should be sited so as not to drain roadways and other outside areas.
- 5.5 Suitable site lighting shall be provided for out of hours nighttime working. Site lighting is to be installed at height of 5m minimum with a fitted an LED light of 150w minimum (colour to be 400k). Site lighting shall be switched independently from the control panel. It is acceptable for the site lighting and the telemetry system to be located on the one column. Additional site lighting may be required at the discretion of NI Water.
- 5.6 A safe and reasonable vehicular access should be provided at all times to accommodate a lorry mounted vacuum tanker (up to 32 tonne G.V.W) with the access route demonstrated via Auto tracking. Access to be directly off a public road or dedicated access road. Shared access with domestic driveways is not acceptable.

## 6.0 SITE WORKS / ACCESS ROAD

- 6.1 Where appropriate, a properly constructed access road shall be provided together with any necessary turning bays and/or passing bays.
- 6.2 The minimum width of the access road shall be 4.0m and the road should be suitable for a lorry mounted vacuum tanker (up to 32 tonne G.V.W).
- 6.3 Road construction will be in asphalt or concrete and must comply with the Civil Engineering Specification for the Water Industry (Current Edition)
- 6.4 Provisions should be made to allow Tanker access to within 3m of the wet well.

## 7.0 BOUNDARY DEMARCATION

- 7.1 The construction of the boundary demarcation shall be in accordance with the NI Water - Site Protection Guidelines (SSW10).
- 7.2 The fence should be 2.4m high from the finished ground level.
- 7.3 Double leaf gates shall also finish 2.4m high from the finished ground level and incorporate an approved locking arrangement.
- 7.4 The width of access gates shall generally be 4.0 metres measured centre to centre of the gate posts, or by agreement.
- 7.5 Slip bolts to suit ASSA / Abloy close shackle padlocks shall be fitted.
- 7.6 Gate support columns will be 150mm x 100mm RSJ with base plates set into concrete foundations.
- 7.7 The top of the gates shall be level with the top of the fence.
- 7.8 Concrete bedding for the posts shall be Grade C20 concrete.
- 7.9 The bases of the fences shall be embedded in Grade C20 concrete.
- 7.10 Where the local Planning Authority stipulate the requirements for fencing and site layout, Health and Safety considerations will take priority.

## 8.0 WATER/ ELECTRICITY SUPPLY

- 8.1 Water By-Law Regulations, Design of the water supply facility must incorporate a type AB Air-gap with a minimum of a 450 litre tank.
- 8.2 Tupe Isolation Valve located outside the WwPS compound within 2m of the gate.
- 8.3 Earth Spike located within the WwPS compound boundary at an accessible location.  
[Vol16WashwaterBoosterv1.0.pdf \(nigov.net\)](#)

## 9.0 WET WELLS

### 9.1 WET WELL GENERAL

- 9.1.1 Northern Ireland Environment Agency may require additional emergency storage.
- 9.1.2 Where a separate storage well is a requirement there shall be a pumping station bypass facility incorporating an agreed valving arrangement. This shall be located upstream of the wastewater pumping station with a free flow discharge back to the wet well.

### 9.2 WET WELL DETAILS

- 9.2.1 The wet well shall be either mass concrete, reinforced concrete or pre-cast concrete rings with a minimum 200mm concrete surround. Photographic evidence of the construction of the wetwell, inclusive of the base and concrete surround prior to backfill, to be produced at time of inspection and included within the O & M Manual.
- 9.2.2 The minimum dimensions of the wet well shall be 2.1m diameter depending on the construction of the well. NI Water are to inspect the installation of the concrete surround. Five days' notice is to be given. If NI Water is not given the opportunity to inspect excavation may be required to confirm.
- 9.2.3 The depth shall be determined by calculation to suit the incoming gravity sewer, emergency overflow, pumping main and the volume required for emergency storage of sewage.
- 9.2.4 Bauer Coupler pipework (fitted with a suitable air pressure relief valve) is required for wet wells whose depth is in excess of 5m. The wet well should be constructed to facilitate the invert of the incoming gravity sewer to be a minimum of 500mm above the pump start level to prevent surcharging during

normal operation.

- 9.2.5 The structures shall finish at the final ground level.
- 9.2.6 Wet wells constructed of precast concrete segment construction, shall be surrounded with not less than 200mm thickness of Class 25N/m concrete.
- 9.2.7 Wet wells constructed of 'in situ' concrete shall be designed in accordance with the current 'Civil Engineering Specification for the Water Industry'.
- 9.2.8 NI Water may ask for the pumping chamber to be filled with water and to be allowed to stand for a period of 7 days after which time the level shall be determined exactly. The water shall stand for a further period of 7 days, the levels being determined daily. If the loss is greater than 15mm, the point or points of leakage shall be determined, the water level being lowered in stages as required. After remedial work the structure shall be re-tested. When the loss is over 7 days does not exceed 15mm, the structure shall be deemed watertight.
- 9.2.9 An Emergency Relief Overflow (ERO) shall be required from the pump wet well to the nearest suitable watercourse as set out in the Water Order Consent issued by Northern Ireland Environment Agency.
- 9.2.10 A suitably sized self-cleansing 6mm static screen shall be installed on the overflow to collect screenings. Alternatively, a separate screening chamber may be required. The screen to be located within the chamber so that it can be cleaned effectively from ground level by the wash water booster set. Screening System to be approved by NI Water. The screen to be positioned so that it is easily accessible for cleaning.
- 9.2.11 It is essential that the level of the overflow is checked to ensure that no out of sewer flooding occurs upstream of the wastewater pumping station.
- 9.2.12 Suitable access must be provided and 2 no. davit sockets must be installed to assist with safe maintenance and the removal of plant and equipment from the site to be located no more than 1m away from any access point to chambers.
- 9.2.13 Approval and consent to discharge in an emergency to a suitable watercourse is required from the appropriate statutory Agencies, e.g. Rivers Agency and the Northern Ireland Environment Agency, prior to NI Water approval being granted.
- 9.2.14 The gravity sewer network should be designed to accommodate one inlet to the wastewater pumping station wet well.
- 9.2.15 The inlet should be provided with an isolation gate valve. Gate valves should be clockwise closing with suitable support brackets installed on the extension spindles included if the depth of the incoming gravity sewer warrants it. The extension spindle is to be terminated in a surface mounted Toby box.
- 9.2.16 All valves supplied should be operated with standard valve key or hand wheels.
- 9.2.17 The correct direction of valve closing must be shown on the valve handwheel.
- 9.2.18 Pumping Station pipework shall be cement lined Ductile Iron (in accordance with BS EN 598) and shall be adequately supported with concrete or metal structures.

### 9.3 EVENT DURATION MONITORS (EDM)

- 9.3.1 EDM Event Duration Monitors are to be fitted within the wet well.
- 9.3.2 The EDM ultra-sonic head should be set to alarm at the invert of the overflow pipe.
- 9.3.3 The EDM read out device should be located in either the main MCC or mounted independently in the GRP kiosk.
- 9.3.4 The EDM unit shall be separate of the pump control ultra-sonic.
- 9.3.5 A telemetry point should be included for the EDM.
- 9.3.6 The EDM should be clearly labelled in the panel & within the wet well.

## 10.0 ACCESS COVERS AND FRAMES

- 10.1 Where a suitable watercourse is not in proximity for discharge of the emergency overflow additional mitigation measures may be required at the discretion of NI Water.
- 10.2 Access lids shall comply with BS EN 124 1994 load/C250, galvanised chequer plate steel and should have torsion spring assistance. Access covers and grids to be approved by NI Water prior to fabrication and installation.
- 10.3 A recessed box for holding a hasp and stable padlocking system should also be specified for the lids. The recess box shall not present a tripping hazard when closed.
- 10.4 The access opening for the wet well must incorporate a split hinged pump-through closed mesh safety grid to enable safe removal of submersible pump, for NI Water approval. Support hook required to locate pump lifting chain when pump in service – to be located at the pump chain access hole in the safety grid. Access covers and grids to be approved by NI Water prior to fabrication and installation.
- 10.5 The covers to the wet well chambers must be a minimum of 900x1800mm.
- 10.6 Each pump must have a dedicated cover which opens independently of each other.
- 10.7 Valve and flow meter chambers require a hinged closed mesh safety grid with the hinges in the same orientation as the hinged cover.
- 10.8 Overflow chambers require a hinged open mesh (cattle grid) type safety grid with the hinges in the same orientation as the hinged cover.
- 10.9 The covers to the valve, overflow and flow meter chambers must be positioned to facilitate access to the chambers, and also to allow withdrawal of valves and associated equipment.
- 10.10 The covers to the valve chamber must be minimum of 900x1400mm.

- 10.11 The covers to the overflow and flow meter chambers must be a minimum of 800 x 800mm.
- 10.12 Lifting and locking keys must be provided.
- 10.13 Lock open facility to be provided for all hinged safety grids.
- 10.14 Danger signage to be fitted to all safety grids.

## **11.0 LADDER**

- 11.1 A stainless-steel ladder shall be provided for man entry into the wet well. Dedicated fall arrest davit socket to be located no more than 1 metre away from any access point to chambers.
- 11.2 All ladders to be located centrally to the 750mm side of the opening with the top of the ladder fixed to the concrete edge of the clear opening to the well. Landing area at the bottom of the ladder is to be level and minimum 400mm x 400mm.
- 11.3 Retractable handposts are to be provided either side of the ladder, self-anchor bolted to the concrete edge of the clear opening.
- 11.4 The access ladder must not be so close to the pump set that it poses a hazard when stepping off or onto the ladder from the wet well floor.
- 11.5 A stainless-steel ladder must be provided in the overflow / storage wet well.
- 11.6 A galvanised steel ladder must be provided in the valve chamber and flow meter chamber.
- 11.7 All steel ladders to be of the retractable safety or other approved type.
- 11.8 All ladders shall comply with "Civil Engineering Specification for the Water Industry" current edition.

## **12.0 VENTILATION**

- 12.1 Ventilation should be provided to the wet well by means of twin inverted 'T' shape 100mm diameter pipes. One pipe shall terminate under the invert level of the overflow pipe (however this is site specific), the second pipe close to the underside of the cover slab. The ventilation pipes should be positioned at the furthest point away from the nearest receptor.
- 12.2 Where it has been determined by NIEA that they are not granting a Water Order Consent to Discharge there is a requirement for additional onsite storage. Easily accessible removable Carbon Filters must be installed in the ventilation pipework.
- 12.3 Galvanised steel ventilators c/w fly-mesh shall be positioned to minimize trip hazards.

## **13.0 ODOUR MANAGEMENT**

- 13.1 Where deemed necessary odour management should be agreed with NI Water dependent upon the needs of individual sites.
- 13.2 A septicity assessment must be provided for consideration by NI Water to establish the risk of odours being generated from the wastewater pumping station or the rising main discharge point due to factors such as length of rising main and lower than designed inflow.
- 13.3 Cost of managing the septicity will be borne by the Developer until such times as Final Adoption is complete, and the station becomes the responsibility of NI Water.

## **14.0 PIPEWORK**

- 14.1 Pipework and fittings shall be ductile iron manufactured to BS EN 598 and shall be flanged.
- 14.2 Pipes passing through walls shall have an integral puddle collar.
- 14.3 Clamps and brackets (corrosion proof) shall be fitted to support pipework if required.
- 14.4 Care must be taken to ensure that the 90° vertical bends on the delivery pipework between the pump wet well and valve chamber are installed vertically and aligned to the pumps.
- 14.5 Pipework should be supported a minimum of 300mm from chamber floor to invert of pipework by corrosion proof brackets.
- 14.6 Care must also be taken when forming concrete floors to valve chambers to ensure that all pipework bolts are left clean easily removable.

## **15.0 VALVE CHAMBER AND VALVES**

- 15.1 The following valves shall be fitted within the valve chamber.  
Reference NIW WWPS-01 – Typical Arrangement of a Wet Well Submersible Pumping Station and Valve Chamber.
  - 15.1.1 2 No cast iron double flanged isolation gate valves with inside screw and wheel handle.
    - 15.1.1.1. Direction of closing must be clockwise and shall be clearly marked on the wheel handle.
    - 15.1.1.2. The valves shall be installed horizontally with a flange adapter on the downstream side of each valve to facilitate removal and refitting.
  - 15.1.2 2 No cast iron double flanged swing check valves with outside lever and anti-slam counter balanced weight with lugs removed for sewerage applications.
    - 15.1.2.1. The valves shall be installed horizontally with a flange adapter on the downstream side of each valve to facilitate removal and refitting.
- 15.2 Pipework from the valve chamber benched floor to the pump wet well shall be 80mm diameter and have a valve fitted to prevent back drainage from the wet well. Where drain pipework pass through the walls of structures, they shall be provided, on the outer side, with flexible joints designed to tolerate differential

settlement.

- 15.3 Pipework and valves should be supported a minimum of 300mm from the chamber floor by corrosion proof brackets.
- 15.4 Minimum size of chamber to be 2.1m for a standard two-pump set up.

## 16.0 FLOW METER CHAMBER

- 16.1 A flow meter chamber is required within the compound for all Pumping Stations.
- 16.2 A flow meter chamber of minimum size 1.8m is required for any wastewater pumping station.
- 16.3 Pipework from the flow meter chamber benched floor to the valve chamber shall be 80mm diameter. Where drain pipework pass through the walls of structures, they shall be provided, on the outer side, with flexible joints designed to tolerate differential settlement.
- 16.4 Flow meter should be installed a distance **5 times the diameter upstream and 3 times the diameter downstream with a straight run of uninterrupted pipe.**
- 16.5 Flow Meter Earthing Rings to be fitted at all times and a separate 'clean earth' to be terminated at the main earth point.
- 16.6 All terminal connections at the flow meter must be potted, as per flow meter manufacturer's recommendation.
- 16.7 Upstream isolation valves must be installed within the flow meter chamber to be accessed from ground level.

## 17.0 PUMPING MAIN – BLACK

- 17.1 The diameter of rising mains shall be such that the velocity of the discharge will not be less than 0.75m/s nor exceed 1.8m/s.
- 17.2 Pressure pipes for rising mains shall comply with BS EN 13244-2 the colour shall be **Black**.
- 17.3 The pumping main shall be constructed in accordance "Civil Engineering Specification for the Water Industry" current edition and laid at a depth of 1.2m in carriageways.
- 17.4 The minimum pumping main internal diameter shall be 80mm.
- 17.5 Pumping mains shall have pumping/rising main indicator tape placed above the pipe bedding before backfilling.
- 17.6 Testing shall be carried out in accordance with Civil Engineering Specification for the Water Industry current edition that includes pressure testing.
- 17.7 Plastic pipes for underground application shall comply with Civil Engineering Specification for the Water Industry and have a minimal rating of PE100.
- 17.8 Plastic pipe joints may be electro-fusion or butt fusion welded.
- 17.9 Where rising mains pass through the walls of structures, they shall be provided, on the outer side, with flexible joints designed to tolerate differential settlement.
- 17.10 All changes in direction in rising mains must be securely anchored, and where necessary provision shall be made for access for cleaning.
- 17.11 Summits should be avoided if possible, in cases where they are unavoidable, air release valves (sewage type; cast iron or stainless steel) must be provided.
- 17.12 Washout facilities shall be provided at any low points.
- 17.13 Hatch boxes shall be installed on the pumping main at distances no greater than 500m apart and shall be located within a manhole.
- 17.14 Valves shall be located on either side of a hatch box.
- 17.15 Suitable pressure testing of the pumping main sewer will be required prior to adoption and results provided and included within O&M manual.

## 18.0 ADOPTION

- 18.1 The Wastewater Pumping Station will form part of the developer's sewerage system and will be included in the adoption process and in conjunction with the sewerage system but will be subject to a separate adoption certificate.
- 18.2 The ownership of the Wastewater Pumping Station site must be legally transferred to NI Water, without cost and with all the associated running costs paid up to date before the station can be adopted.
- 18.3 In the unlikely event of NI Water paying the electrical running costs in advance of adoption the Developer will pay back to NI Water all monies outstanding.
- 18.4 An accurate site dimension plan suitable for registration purposes shall be agreed with the Developer's Solicitor and uploaded to the NI Water Self Service Portal, stating that the land indicated is ready for transfer to NI Water, as a prerequisite to the adoption of a sewerage system by NI Water under Article 161 of the Water and Sewerage Services (Northern Ireland) Order 2006 (as amended Water and Sewerage Services Act (Northern Ireland 2016)). When deemed satisfactory land will be transferred under the ownership of NI Water.
- 18.5 In addition, all manuals, Health & Safety files and Risk Assessments must be provided digitally to NI Water prior to the Wastewater Pumping Station being handed over.
- 18.6 NI Water should be notified of commissioning of the Wastewater Pumping Station inclusive of telemetry and prior to handover the pumps should be tested to prove they meet the performance criteria by use of a simple drop test or the pump control device. The flow rate of the pumps shall be tested in duty and duty standby mode and the stop- start levels and alarm levels controls validated and recorded.

- 18.7 When applying for adoption NI Water must be supplied with “as built drawings” for verification as per Article 161 Agreement and an O&M Manual, including all necessary information applicable to the site (to NI Water Wastewater Asset Performance Standards) e.g. lifting test certificates (Davit Sockets and lifting chains (LEAPS)), electrical test certificates (NICEIC), cable schedule and calculations.
- 18.8 NI Water will require a copy of the Water Order Consent issued by NIEA to an agreed discharge point.
- 18.9 Wastewater Pumping Stations should be completed and offered for Preliminary Adoption no greater than five years from the date the Article 161 Agreement was authorised. Failure to do so will involve the Developer bringing the Wastewater Pumping Station up to the NI Water Specification current at the time of requested adoption.
- 18.10 At the pre-adoption inspection NI Water will, if deemed necessary, prepare a list of Civil / M & E defects for remedial action by the developer.
- 18.11 If it is determined at a second pre-adoption meeting that defects highlighted at the previous meeting have not been attended to, NI Water reserve the right to charge the developer for each of the subsequent adoption inspections.
- 18.12 A Copy of the NI Water educational leaflet to be issued to all houses discharging to the wastewater pumping station. The leaflet can be found at <https://www.niwater.com/bag-it-and-bin-it/>

**19.0 BOND SURETY / RECHARGEABLE**

- 19.1 In the event of recurring problems within the station and complaints from residents of public health and odour related problems caused by the station and failure by the Developer to respond to complaints, prior to the Adoption by NI Water, NI Water reserve the right to carry out works and recover the costs from the Bond Surety to make good recurring problems caused by pump failure or carry out the work on a rechargeable basis.

**20.0 MAINTENANCE**

- 20.1 The plant shall be guaranteed against defective materials and workmanship and managed by the Developer until such times as Final Adoption is complete, and the station becomes the responsibility of NI Water.
- 20.2 A pump conditioning report must be included within the O&M Manual.
- 20.3 Wet well should be cleaned and de-gritted prior to hand over.



**21.0 ELECTRICITY METER INSTALLATION/ELECTRICAL COSTS**

- 21.1 As part of NI Water’s business improvements, electricity service provider meters have been upgraded therefore when new supplies are being connected you should ask for a code 5, class 1 on-line half hour meter.
- 21.2 The meter should be located within the MCC kiosk and come complete with an internal modem with GSM communications or alternatively if there are communications problems then an internal modem capable for connection to a BT line. This will enable NI Water to dial up electricity service provider electricity meters for data acquisition and energy management. The Developer must discuss this with NI Water prior to meter installation.
- 21.3 At Preliminary Certificate of Completion stage, NI Water will require MPRN, (Meter Point Reference Number, 11-digit no. provided by electricity service provider) and the electricity meter serial number.
- 21.4 NI Water will take over payment of electrical costs once the station has been given Final Adoption Certification.
- 21.5 The Developer will arrange for a meter reading after at the handover stage when the station is formally accepted and will be responsible for the payment of this reading.
- 21.6 The meter will then be signed over to NI Water’s responsibility, commencing from the meter reading date.

**22.0 ELECTRONIC DETAILS AND INFORMATION**

- 22.1 Details about the installation will be held electronically on the Company’s Geographical Information System (GIS) to assist with maintenance and out of hour’s emergency response.

**TYPICAL WWPS CIVIL DRAWINGS – Appendix B**

<b>NIW WWPS01</b>	Typical arrangements of WWPS	
<b>NIW WWPS02</b>	Typical Site Layout	
<b>NIW WWPS03</b>	Standard Flush Mount Davit Socket	

## SECTION 2 - M & E SPECIFICATION FOR WASTEWATER PUMPING STATIONS

### PART A - M & E SPECIFICATIONS FOR WASTEWATER PUMPING STATIONS– PUMP SPECIFICATION

#### 23.0 INTRODUCTION

- 23.1 The wastewater pumping station shall incorporate two identical submersible pump sets arranged in a duty/standby configuration.
- 23.2 The pump sets shall be of the single stage, centrifugal, end suction type suitable for pumping untreated sewage containing fibrous material (rags, paper etc.), solid faecal matter and grit.
- 23.3 The pump sets shall comply with all relevant Statutory Regulations and the current editions of all relevant British and Harmonised European Standards
- 23.4 The pump sets shall also comply with:
  - 23.4.1 this Specification and WIMES 1.02
  - 23.4.2 any other Standards or Particular Specifications issued by, or on behalf of NI Water.
- 23.5 Where the documentation referenced in Section 2: 1.4 imposes additional requirements to a British or Harmonised European Standard, the requirements of the documentation referenced in Section 2: 1.4 shall prevail.
- 23.6 Where there is conflict between the documentation referenced in Section 2: 1.4a and Section 2: 1.4b, the requirements of the documentation referenced in Section 2: 1.4b shall prevail

#### 24.0 PERFORMANCE REQUIREMENTS AND INFORMATION

- 24.1 The maximum operating speed of the pump sets should be 1500rpm.
- 24.2 Each pump set shall be capable of pumping the design flow rate.
- 24.3 The pump sets shall be capable of continuous operation within the design operating envelope.
- 24.4 Pump set cable length to be designed so that not to have any connections/joints between the pump set and the associated starter sections at the MCC.
- 24.5 The pump sets shall have stable head vs. flow rate characteristics against the system curve(s) (i.e. each pump sets head vs. flow rate curve shall slope upwards towards closed valve with reducing flow rate in one continuous curve with no points of inflection capable of causing hunting when considered against the system curve(s)).
- 24.6 The pump sets shall be selected such that the design flow rate is between 80 % and 105 % of the pump set best efficiency point (BEP) flow rate.
- 24.7 The pump sets shall be capable of discharging into an empty main (i.e. the pump sets shall have non-overloading head vs. flow rate characteristics).
- 24.8 The pump sets shall be capable of operating against a closed valve for short periods of time
- 24.9 The pump sets shall be capable of continuous operation with the motor housing uncovered.
- 24.10 The maximum diameter of solid sphere able to be passed by the pump sets shall generally be in accordance with the guidelines given in Table 3.
- 24.11 Where the pump sets feature an innovative design, which does not allow compliance with the Table 3, the Developer shall provide substantiating information, for approval, to demonstrate that the solids handling performance of the pump sets will satisfy NI Water's requirements (i.e. the pump sets will be capable of prolonged, reliable and trouble-free operation):

**Table 3**

Nominal Bore of Outlet (mm)	Diameter of Solid Sphere Able to be Passed (mm)
80	60
<= 100	75
> 100 but <= 125	90
> 125 but <= 175	120
> 175	150

- 24.12 The pump sets shall be reliable, efficient, and capable of operating between the manufacturer's recommended service intervals without attention or inspection.
- 24.13 Pump sets shall have an expected design life of a minimum of 7 years.

#### 25.0 DESIGN REQUIREMENTS

- 25.1 Materials Selection
  - 25.1.1 Pump set materials shall be selected with reference to the operating environment, pumped liquid and expected design life. Where there is a risk of saline ingress into the wet well, pump set materials shall be selected accordingly
  - 25.1.2 Where surfaces (such as stainless-steel wear rings) may be subject to galling, materials shall be selected to minimise wear and have a minimum hardness differential of 50 HB
- 25.2 External Corrosion Protection

- 25.2.1 Protective coatings shall be selected with reference to the operating environment, pumped liquid and expected design life.
- 25.3 Noise
- 25.3.1 The noise levels from each pump set shall not exceed 85 dB (A) at a distance of 1m from the pump set centre line (based on the pump set being mounted in 'semi-reverberant' conditions).
- 25.4 Mounting Arrangements
- 25.4.1 Each pump set shall be supported from and automatically coupled to the outlet pipework by its own weight and shall be positively guided during installation and removal operations. The guide system shall allow the pump set to be raised to the top of the wet well without the need to undo any fixing arrangements or enter the wet well.
- 25.4.2 Twin circular cross-section tubes shall be provided as the guide system. The tube(s) and fixings shall be made from stainless steel.
- 25.4.3 The interface between the pump set outlet flange and the outlet pipework shall be effectively sealed.
- 25.4.4 The tops and bottoms of the guide tube(s) shall be located by suitably designed brackets and spigots respectively, having minimum lengths of engagement equivalent to the bore of the guide tube(s).
- 25.4.5 The maximum length of any unsupported guide tube span shall be 3 metres.
- 25.4.6 Hooks shall be provided at the top of the guide tube(s) for securing the cable support sleeves and for parking the lifting chain, if provided.
- 25.4.7 All spigots, brackets, and hooks shall be made from stainless steel.
- 25.4.8 All fasteners (nuts, bolts, etc.) shall be made from stainless steel.
- 25.4.9 Insulating washers and sleeves shall be used to prevent direct contact between dissimilar metals to prevent electrochemical corrosion.
- 25.5 Casings
- 25.5.1 Casings shall be designed to resist abrasion and mechanical shock loads imposed by solids in the pumped flow.
- 25.5.2 The outlet connection of each pump set (typically the 'duck foot' bend) shall terminate with flange type PN16 (minimum), as detailed in BS 4504: Part 3.
- 25.5.3 All casing surfaces having a fine clearance between fixed and rotating components shall be provided with renewable wear parts that are easily removable for refurbishment or replacement.
- 25.5.4 The direction of rotation of the impeller shall be clearly and indelibly marked on the pump casings with an arrow.
- 25.6 Impellers
- 25.6.1 The impeller type shall be selected to prevent fouling, allow the passage of fibrous and solid materials and suit the operating conditions.
- 25.6.2 Impellers shall be hardened and one-piece castings.
- 25.6.3 Impellers shall not be pinned or screwed to shafts, nor shall shaft rotation be relied upon to ensure that impellers are locked in position.
- 25.6.4 With the exception of single vane impellers, impellers shall be statically balanced in two planes to achieve balance quality grade G6.3, in accordance with BS 6861. Balancing shall be achieved by machining, not addition of weights.
- 25.6.5 All impeller surfaces having a fine clearance between fixed and rotating components shall be provided with renewable wear parts that are easily removable for refurbishment or replacement
- 25.7 Shafts
- 25.7.1 The first critical speed of the rotating elements (i.e. the shaft, motor rotor and impeller etc.) shall be at least 25 % above the maximum operating speed.
- 25.7.2 The shaft stiffness shall be such that, under the most severe conditions of operation, the total shaft deflection at the seals does not exceed the seal manufacturer's specified tolerances.
- 25.7.3 If the shaft is exposed to the pumped sewage, it shall be manufactured from a corrosion resistant material or be protected by a sleeve.
- 25.7.4 Shaft Sleeves (where provided) shall:
- be manufactured from a material that will not cause galvanic corrosion between itself and the shaft.
  - be positively driven.
  - have seals provided to prevent leakage of the pumped sewage between shafts and sleeves.
- 25.8 Seals
- 25.8.1 Sealing between the casing volute and motor enclosure shall be achieved by primary (casing volute to oil chamber) and secondary (oil chamber to motor enclosure) mechanical seals and by an oil filled chamber between the primary and secondary seals.
- 25.8.2 Where the pump sets feature an innovative sealing arrangement that does not incorporate an oil filled chamber, the Developer shall provide substantiating information, for approval, to demonstrate that this sealing arrangement will satisfy NI Water requirements.
- 25.8.3 Stationary and rotating rings shall be composed of a single material i.e. wear resistant coatings shall not be used.
- 25.8.4 Seal component materials shall be compatible with the pumped sewage.
- 25.9 Bearings and Bearing Lubrication
- 25.9.1 Rotating assemblies (motor rotor, shaft and impeller) shall be supported by grease lubricated upper and lower rolling element bearings.

- 25.9.2 Bearings shall have a minimum L10h life of 50,000hrs at the design operating conditions.
- 25.10 Information Plate
- 25.10.1 Each pump set shall be provided with an information plate permanently fixed to one of the major pump set components.
- 25.10.2 The plate and its fixings shall be manufactured from corrosion resistant, metallic materials.
- 25.10.3 As a minimum, the information plate shall include the following information:
- a). pump set manufacturer
  - b). pump set type
  - c). pump set serial number
  - d). impeller number or diameter
  - e). flow rate at the duty point (l/s)
  - f). head at the duty point (m)
  - g). operating speed (rpm)
  - h). motor rating (kW)
  - i). operating voltage (V), no. of phases and frequency (Hz)
  - j). full load current (A)
  - k). full load power factor
  - l). insulation class
  - m). enclosure classification (IP rating)
  - n). hazardous area classification
  - o). pump set weight
- 25.10.4 Pump information plates shall be provided, fixed to the front of the associated pump starter section at the MCC.
- 25.10.5 Labels, indicating 'Pump No.1' and 'Pump No.2', shall also be provided in a clearly visible position near the top of the wet well.
- 25.11 Pump set Lifting Points
- 25.11.1 Each pump set shall be provided with clearly identified, permanent, corrosion resistant lifting points, located to give a safe, balanced, lift.
- 25.12 Lifting System
- 25.12.1 Where the lifting system consists of lifting chains and a davit arrangement, the following clause, 3.13.2 'General', 3.13 'Davits and Davit Sockets' and 3.14 'Chains' shall apply
- 25.12.2 General
- 25.12.2.1. All lifting equipment (including attachments for anchoring, fixing or supporting the lifting equipment) and lifting accessories (chains, eyebolts etc.) shall comply with the Lifting Operations and Lifting Equipment Regulations (LOLER) and the Provision and Use of Work Equipment Regulations (PUWER)
  - 25.12.2.2. All lifting equipment and lifting accessories shall be visibly and indelibly marked with their Safe Working Loads (SWL's).
  - 25.12.2.3. The Developer shall provide NI Water with the original test certificates for all lifting equipment and lifting accessories
  - 25.12.2.4. Copies of all test certificates shall be inserted in the Waste Water Pumping Station O & M Manuals.
- 25.13 Davits and Davit Sockets
- 25.13.1 Davits and davit sockets shall be designed and positioned to provide lifting equipment with a vertical pull on the pump sets and valves over 20kg to enable pump sets to be readily raised or lowered on their guide rails and removal of valves for maintenance purposes. They must also be provided for personnel entry.
- 25.13.2 Davits and davit sockets shall be rated to lift twice the weight of each pump set, subject to a minimum SWL of 500kg.
- 25.13.3 Davits shall be made from mild steel, hot dipped galvanised to BS EN ISO 1460 and have a maximum weight of 35kg.
- 25.13.4 To prevent the ingress of water and debris into davit sockets, cover plates, flush with the top of the surrounding concrete, shall be provided.
- 25.14 Chains
- 25.14.1 Chains shall be of the stainless-steel short link type to BS EN 818-1 and certified as lifting chains by an accredited company. Name plate to be available on the pump lifting chains and test certification to be provided to NI Water.
- 25.14.2 To assist in lifting, chains shall incorporate larger links with a minimum internal diameter of 50mm, spaced at a maximum of 1 metre intervals along their length.
- 25.14.3 Chains shall be rated to lift twice the weight of each pump set, subject to a minimum SWL of 500kg.
- 25.14.4 Where the chains remain attached to the pump sets during pump set operation, they shall be securely fixed to the pump sets with stainless steel fittings and test certification to be provided to NI Water. The loose ends of the chains shall be attached to a corrosion resistant hook, readily accessible from outside the wet well.



25.14.5 The length of the chains shall be such that when the pump sets are in position, the chains extend at least 2m above the top of the wet well

#### 25.15 Cable Support System

25.15.1 Cables shall be securely anchored inside the wet well.

25.15.2 The method of securing the cables shall avoid excessive stressing of the cables and allows the pump sets to be withdrawn from the wet well without fouling the cables.

25.15.3 The anchor shall be capable of ready release.

### 26.0 Pump set PROTECTION SENSORS

26.1 In addition to any motor protection systems required for hazardous area certification, pump sets shall be equipped with condition monitoring and protection sensors for:

26.1.1 preventing overheating of the insulation (to be achieved by at least two thermal switches embedded in the stator winding coils); and

26.1.2 detecting seal failure.

26.2 The pump sets shall incorporate any fixings required for the location of condition monitoring and protection sensors.

### 27.0 TESTING

27.1 The pump sets shall be tested at the manufacturer's premises to BS EN ISO 9906:2012 to demonstrate that they are capable of achieving the specified design duty. Type-test curves are acceptable for verification of performance.

27.2 Characteristic curves of pump generated head, efficiency, and pump and pump set absorbed power versus flow rate shall be provided before the pump sets are delivered to site.

27.3 Hydraulic drop tests shall be carried out by the Developer on site in the presence of NI Water to verify the theoretical performance of each pump set. The results of these tests shall be recorded and placed in the O & M manuals.

# **PART B – MOTOR SPECIFICATION**

## **28.0 INTRODUCTION**

- 28.1 This specification defines the requirements for motors forming part of two-pump pumping stations for use in the Water Industry.

## **29.0 PERFORMANCE REQUIREMENTS**

- 29.1 General
  - 29.1.1 Motors shall be capable of continuous operation under the operating conditions of the pump set.
- 29.2 Electrical Supply
  - 29.2.1 Motors shall be suitable for a 400V, three phase, three wire, earthed neutral, 50 Hz supply and have a minimum of IE 2 efficiency rating.
  - 29.2.2 Tolerances on the supply shall be +10/ -6 % on voltage and +/- 1 % on frequency.
- 29.3 Duty and Rating
  - 29.3.1 Each motor shall have a maximum continuous (MC) rating, based on duty type S1 (as defined in BS EN 60034-1), equal to at least 110 % of the maximum load (absorbed power) of the pump set over its operating range.
  - 29.3.2 The load (absorbed power) at the duty point shall not be less than 75 % of the MC rating of the motor.
- 29.4 Starting
  - 29.4.1 Motors shall be capable of handling a maximum of (i.e. up to) 15 starts per hour.

## **30.0 DESIGN REQUIREMENTS**

- 30.1 Enclosure and Cooling
  - 30.1.1 Motors shall have an enclosure classification of IP68 in accordance with BS EN 60529 and be suitable for operation whilst continuously submerged to a depth of 10 metres.
  - 30.1.2 Motors shall incorporate a cooling system that will allow the pump sets to run, without de-rating, over their full operating range.
- 30.2 Insulation
  - 30.2.1 Motors shall have Class F insulation in accordance with BS 2757 and the temperature rise limit shall be Class F in accordance BS EN 60034-1, as measured by the resistance of the windings during full load operation.
- 30.3 Cables and Connection of Cables
  - 30.3.1 Each pump set shall be supplied and fitted with a cable of a suitable length for the duty.
  - 30.3.2 Cables shall be suitably rated for the duty, be constructed in accordance with BS 6007 with oil and weather resistant chloroprene rubber or equivalent sheathing and comprise power and auxiliary cables necessary for the motor supply and all protection circuits.
  - 30.3.3 Each cable shall incorporate an earth conductor.
  - 30.3.4 After the cable installation, the cable ducts shall be sealed.
- 30.4 Dangerous Substances and Explosive Atmosphere DSEAR (N.I)
  - 30.4.1 To ensure compliance with NI Water's DSEAR Code of Practice all WWPS wet wells shall have a minimum area classification of Zone 2.
  - 30.4.2 All equipment installed must therefore be suitable for operation in such an environment and shall be certified accordingly.
  - 30.4.3 The designer is responsible for ensuring compliance with DSEAR Code of Practice 01 and must seek formal clarification prior to design implementation.
  - 30.4.4 Both equipment certificates and installation certificates shall be provided prior to handover from a qualified installer.

# PART C – ELECTRICAL SPECIFICATION

## 31.0 SCOPE

- 31.1 This Specification defines the requirements for electrical equipment forming part of two-pump pumping stations for use within NI Water.
- 31.2 This electrical equipment shall typically comprise:
  - a). a kiosk
  - b). a control panel
  - c). an incoming power supply including GSM MV90 half hour electricity meter
  - d). two pump sets
  - e). all associated interconnecting cabling and wiring
  - f). pump/ motor controller
  - g). primary and secondary level control system
  - h). high level float switch

## 32.0 GENERAL

- 32.1 General
  - 32.1.1 The Developer shall obtain an 'Application to Connect' form from the electricity service provider.
  - 32.1.2 This shall be completed and signed by the Developer and submitted to the electricity service provider when the installation is ready for connection to the electricity supply.
  - 32.1.3 Before the form is sent to the electricity service provider, it shall be submitted to NI Water so that the tariff agreement can be checked.
  - 32.1.4 Motors above 3.75kW should have assisted start.
  - 32.1.5 The Developer shall obtain electricity service provider approval of the starting arrangements.
  - 32.1.6 The incoming electricity supply to the pumping station shall be 400V, 3-phase and neutral, 4 wire, 50 Hz.
  - 32.1.7 The earthing arrangement shall be TNCS.
  - 32.1.8 A GSM half hour electricity meter, MV90 compatible complete with modem shall be installed.
  - 32.1.9 The pumping station shall comply with the requirements of the electricity service provider.
  - 32.1.10 All electrical equipment shall be suitable for the environmental conditions present on site, particularly with respect to corrosion resistance.
  - 32.1.11 All electrical equipment shall be suitable for the environmental conditions present on site, particularly with respect to corrosion resistance.
  - 32.1.12 The pumping station shall be suitable for use by electrically unskilled persons.
  - 32.1.13 All electrical installation work shall either be carried out by a contractor registered by the National Inspection Council for Electrical Installation Contracting (NICEIC)
  - 32.1.14 On completion of the electrical installation, the Developer shall carry out the following tests:
    - 32.1.14.1. All relevant tests specified in the current BS 7671 Regulations with particular reference to IEE Guidance Note 3: Inspection and Testing.
    - 32.1.14.2. Functional tests of control circuitry to confirm that the pumping station operates in accordance with the schematic diagrams and the required control sequence.
  - 32.1.15 Following the satisfactory completion of tests, the Developer shall provide NI Water with:
    - 32.1.15.1. an Electrical Installation Certificate, as required by the current BS 7671 Regulations.
    - 32.1.15.2. a copy of the test schedule relating to functional tests above, detailing the times and dates when all tests were performed. A signed declaration that the pumping station operates in accordance with the schematic diagrams and the required control sequence shall also be provided.
    - 32.1.15.3. Certificates of Conformity.
- 32.2 Labels and Safety Signs
  - 32.2.1 Labels and safety signs shall be written in English and be unambiguous, durable and legible.
  - 32.2.2 Labels shall be attached directly or adjacent to the electrical equipment to which they refer but not to trunking covers or other easily removable or transferable items.
  - 32.2.3 The fixing of labels, safety signs and notices shall not affect the IP rating of the electrical equipment.
  - 32.2.4 Labels shall be attached using an appropriate number of corrosion resistant, mechanical fixings.
  - 32.2.5 Labels mounted on the outside of an enclosure (e.g. control panel, junction box, local control station etc.) shall be manufactured from laminated plastic, engraved to produce black letters on a white background
  - 32.2.6 Labels mounted on the inside of an enclosure shall be to the same standard or may alternatively be printed using an approved proprietary system
  - 32.2.7 Characters shall be upper case and for:
    - a). application labels be not less than 6mm in height
    - b). designation labels be not less than 4mm height and
    - c). component identification labels to be not less than 3mm in height.
  - 32.2.8 Internal components shall be clearly identified by individual labels and have circuit designations which correlate with the installation drawings and documentation.

- 32.2.9 Where this is not practical due to space restrictions, common labels (e.g. laminated diagrams) may be used.
- 32.2.10 Fuse labels shall detail the fuse rating.
- 32.2.11 The lettering, colour and layout of safety signs shall comply with BS 5499-5:2002 and the Health and Safety (Safety Signs and Signals) Regulations, 1996.
- 32.2.12 Safety Signs shall be provided to avoid danger to personnel and to provide compliance with BS 7671:2008+A1:2011 and Statutory Regulations.
- 32.2.13 As a minimum, safety signs shall be fitted to removable covers over bus-bars and live connections, and to doors of compartments containing:
- incoming supply cable termination points;
  - incoming supply switching and isolation devices;
  - an internal switching and isolation device;
  - more than one supply or multiple control circuits originating elsewhere;
  - equipment located within a 'safe area' but associated with certified apparatus located within a hazardous area; a sign shall also be fitted at the safe area cable termination rail; and
  - voltages greater than or equal to 230V, where such voltages would not be expected.
- 32.2.14 Self-adhesive, vinyl safety signs may be used where there is no requirement for a special legend and proprietary safety signs are available.
- 32.3 Operation and Maintenance Documentation
- 32.3.1 At least four weeks prior to the pumping station being transferred to NI Water, i.e. adopted, the Developer shall submit to NI Water for approval, 1 no copy of Operation and Maintenance Manual.
- 32.3.2 When adopted an additional approved 1 no paper copy and an electronic copy on CD /DVD of the manuals shall be handed over.
- 32.3.3 All the manuals shall contain, at LEAST the following information:
- An introduction to the general description of the plant and its operation.
  - Instruction for routine maintenance with charts showing the quantity and type of lubricant to be used, together with the recommended frequency of application.
  - Where applicable, fault finding charts to assist in procedures.
  - A complete list of equipment supplied with details of manufacturers, model, type and serial numbers.
  - Spare parts lists with the names, full addresses and contact names for suppliers.
  - Copies of wiring schematics and pipework system, plant layout 'as fitted', etc. Copies of wiring schematics shall be of legible detail.
  - All test certificates, pump performance tests, electrical tests, declaration of conformity for all relevant plant, etc.
  - A list of set points, telemetry signals and alarm settings, SWR, communications data such as radio power settings, radio license, scanner and site to scanner bearing.
- 32.3.4 A collection of manufacturers' descriptive literature, instruction sheets, charts, lists, pamphlets, etc will not be acceptable in place of the operation and maintenance manuals but may be accepted as complementary, provided they are contained in suitable bindings and clearly marked with the name of the development / wastewater pumping station.

### 33.0 SUPERSTRUCTURE/ELECTRICAL EQUIPMENT KIOSK

#### 33.1 General

- 33.1.1 The superstructure for the wastewater pumping station shall be of the GRP kiosk type and shall generally as shown on the accompanying drawing NIW-WWPS 11 of this specification.
- 33.1.2 The kiosk shall house the following equipment:
- electricity service provider supply and metering equipment.
  - Control Panel and matting to be provided at the front of the panel.
  - Telemetry Outstation facility.
- 33.1.2.4. Kiosk heating and lighting system.

#### 33.2 Kiosk Construction

- 33.2.1 The enclosure shall be to external dimensions 1800mm(H) x 2100mm(W) x 500mm(D), using first quality isophthalic gel coat pigmented to BS 14C39 (or similar and approved British Racing Green colour) and applied at a rate of not less than 0.8kg/m<sup>2</sup>. Vandal proof kiosks to be supplied to be approved by NI Water.
- 33.2.2 Note the overall dimensions of this kiosk to allow for a Talus T4e outstation installation.
- 33.2.3 This is to be followed by 450g/m<sup>2</sup> chopped strand mat wet out with first quality polyester orthothalic resin to BS 476-7:1997 Spread of Flame at a ratio of not more than 2.8:1 (Resin: Mat).
- 33.2.4 30mm thick foam to a density of 32-35kg/m<sup>3</sup> and to BS 476 Part 7 BS 476-7:1997 Class 1 to be encapsulated within the above laminate to give an overall wall thickness of approximately 40mm.
- 33.2.5 Vertical timber battens, spaced at the appropriate centres, are to be encapsulated by further layers of 450g/m<sup>2</sup> chopped strand mat, wet out as above.
- 33.2.6 50 x 50 x 3mm steel angle is to be encapsulated along the full length of the internal base flange.

- 33.2.7 All internal surfaces to be coated with a glaze coat applied at a rate of not less than 0.8kg/m<sup>2</sup>.
- 33.2.8 The doors shall be manufactured with 30mm polyisocyanurate foam core and 100 x 19 timber frame.
- 33.2.9 The doors shall incorporate the following:
- 100mm stainless steel butt hinges to BS EN 1935:2002 Class 13 fitted to each door with A2 S/S fixings.
  - Wind Stops: 1 no. overhead heavy duty 'lock open' aluminium door restraint per door.
  - Door Seal: 12mm x 25mm medium density closed cell PVC foam water seal.
  - Locks: Non-lockable spring-loaded catches fitted to interior of non-locking door.
  - Doors shall be fitted with a S/S handle incorporating a hasp and staple and fitted to internal 3-point locking system to suit NI Water locking system.
- 33.2.10 Through ventilation shall be provided by means of soffit ventilation i.e. adequate space between roof and walls.
- 33.2.11 Resin coated 12mm WBP plywood backboard shall be fixed to the back wall of the enclosure.
- 33.2.12 The enclosure is to be complete with a generator flap to allow cable access. This flap shall be secured in the closed position with a spring-loaded catch fitted to interior of the flap.
- 33.3 Kiosk Mounting Arrangements
- 33.3.1 The kiosk shall be mounted 150mm above the finished ground level on a concrete plinth. The plinth shall extend a minimum of 125mm beyond the kiosk walls and have chamfered edges.
- 33.3.2 The surface of the plinth shall be sufficiently level to ensure that the kiosk will seat correctly on the plinth and that the kiosk doors will open and close without any fouling or forcing.
- 33.3.3 All fasteners and shims required to secure the kiosk to the plinth shall be manufactured from stainless steel.
- 33.3.4 The bottom flange of the kiosk and plinth shall be sealed with a rubber gasket to prevent water ingress. If this is not successful then a concrete screed shall be poured to the kiosk internal floor to assist sealing.
- 33.4 Kiosk Size and Positioning
- 33.4.1 The kiosk shall be positioned so that:
- There is minimum of 3 metre clear space in front of the kiosk (the first metre to be hard standing).
  - Operators can have an unobstructed view of the top of the wet well whilst attending the control panel.
  - The doors of the kiosk do not open onto any access cover/manhole or cause an obstruction.
  - No danger will arise to operators through working on or operating the equipment within the kiosk whilst the access covers of the wet well, valve chamber, etc. are open.
  - There is sufficient space to offload and position a standby generator adjacent to the kiosk.
  - The base of the kiosk is above flood level; and
  - The kiosk is outside any hazardous areas.
- 33.5 Kiosk Heating and Lighting Arrangements
- 33.5.1 The kiosk shall be equipped with a number of suitably rated, tubular, anti-condensation heaters. The mains supply for the heater(s) shall be derived from the control panel and controlled by a tamper-proof thermostat mounted on the wooden backboard of the kiosk. The thermostat shall be set at 5 Centigrade.
- 33.5.2 A 58-watt 1500mm, IP 56, single fluorescent light fitting shall be securely mounted inside the kiosk at roof level to illuminate the control panel and all associated equipment. The mains supply for the light fitting shall be derived from control panel and switched via the on/off switch on the control panel
- 33.6 **NOTE:** Other types of super-structure may be considered following agreement with NI Water, e.g. cast iron or steel to suit a particular development.

## 34.0 CONTROL PANEL

### 34.1 General

- 34.1.1 The control panel shall be manufactured in accordance with NI Water Standard Specification SS200E and WIMES 3.01 and the accompanying drawings in the appendices.
- 34.1.2 The control panel shall be CE marked by the manufacturer before delivery. Appropriate reference to the relevant CE directive (Low Voltage and/or EMC Directives) shall be provided adjacent to the CE mark.
- 34.1.3 The control panel drawings utilised shall be that as issued with this standard specification. Any panel manufactured without approval shall be deemed unacceptable.
- 34.1.4 The control panel shall be mounted on the backboard of kiosk.
- 34.1.5 The control panel shall incorporate the following functional units as shown on NI Water standard Wastewater Pumping Station drawings:
- An incomer compartment.
  - 'Pump No.1' motor starter compartment.
  - 'Pump No.2' motor starter compartment.
  - Common control compartment.
  - Generator Terminals compartment.
  - Cable marshalling compartment or cable-way.

- 34.1.6 Digital
- Phase (Mains Fail) failure.
  - Pump No.1 Run.
  - Pump No.1 Trip.
  - Pump No.1 Auto.
  - Pump No.2 Run.
  - Pump No.2 Trip.
  - Kiosk Door Open.
  - Ultrasonic Status.
  - Wet Well High-Level Status (Overflow Float Switch).
- 34.1.7 All electrical components shall comply with BS EN 60947 Parts 1-7.
- 34.2 Type Testing
- 34.2.1 The control panel shall be type-tested or partially type-tested in accordance with BS EN 61439-2:2009.
- 34.2.2 For both cases, documentation, in the form of test certificates, calculations and/or declarations of conformity, shall be provided to confirm compliance with BS EN 61439-2:2009 with respect to the following:
- Temperature rise limits.
  - Dielectric properties (if applicable).
  - Short-circuit withstand strength tests
  - Effectiveness of protective circuits.
  - Clearance and creepage distances (if applicable).
  - Mechanical operation tests.
  - Degree of protection (IP rating).
  - Electro Magnetic Compatibility (EMC).
- 34.2.3 With respect to the short-circuit withstand testing element of effectiveness of protective circuits, verification is not required for:
- control panels having a rated short-time withstand current or rated conditional short-circuit current not exceeding 10kA; or control panels protected by current limiting devices having a cut-off current not exceeding 17kA at their rated breaking capacity.
- 34.3 Construction
- 34.3.1 The control panel shall comprise an 'enclosed assembly' of the cubicle type, as defined in BS EN 61439-2:2009. The IP rating of the control panel shall be IP54 (minimum).
- 34.3.2 The control panel shall be constructed from mild steel with either of the following substrate pre-treatment / protective coating systems, designed to achieve a minimum 20-year life expectancy.
- 34.3.3 The control panel shall be Form 4a, sub-division type 1, with bottom or side cable entry.
- 34.3.4 The control panel, including doors and covers, shall be suitably braced to produce a rigid structure.
- 34.3.5 Gland plates shall be a minimum of 2.0mm thick or, if thinner, be of braced construction to avoid distortion.
- 34.3.6 Gland plates shall maintain the IP rating of the enclosure.
- 34.3.7 The control panel shall be mounted in such a way that all components are accessible from the front and there is adequate clearance to enable easy installation, removal and maintenance.
- 34.3.8 Doors shall open without fouling or damaging adjacent door mounted equipment and shall have vertical hinges providing an angle of opening of at least 95 degrees.
- 34.4 Principle of Operation of Control System
- 34.4.1A 3-position selector switch on the control panel submersible pump set starter section door shall be capable of the following modes:
- Hand:- In this mode the submersible pump set shall be started, stopped via push buttons on the control panel starter section door.
  - Off: - In this mode the submersible pump set shall not be capable of starting under any circumstances.
  - Auto:- Under normal circumstances (i.e. the Pump station controller and ultrasonic measuring device are both serviceable), in this mode the duty submersible pump set shall operate when the level in the wet well reaches the 'duty start' level and will continue to operate until the level in the wet well falls to the 'common stop' level.
- 34.4.2 Modes of Operation
- 34.4.2.1 If the mode of operation of the pump sets is Duty/Standby:  
If the level in the wet well continues to rise to the 'standby start' level, the duty pump will be inhibited, and the standby pump set shall operate and will continue to operate until the level in the wet well falls to the 'common stop' level.
- 34.4.3 The Alternate Duty Switch shall select automatic cycling of the pump sets, i.e., the pump duty shall alternate at a pre-definable ratio of typically 5:1, making optimal use of the most efficient pump, when the common stop level is reached. This efficiency facility shall be configured within the Alternate Duty Switch. In the event of one of the pump sets being switched off, tripped or auto-available not selected the other pump set shall continue to function.

- 34.4.4 In the automatic mode of operation an Alternate Duty Switch located in the common control section of the control panel and an ultrasonic level transducer located in the wet well shall be capable of controlling the pump sets.
- 34.4.5 A float switch located in the wet well shall detect and indicate high level (overflow). This will trigger an alarm signal in the common control section.
- 34.4.6 An emergency switch push button, located on common control section, shall be capable of switching off the electrical supply to the pumps in any of the above modes. The pumps shall not restart until the fault-reset push button on the starter section door has been pressed.
- 34.4.7 The submersible pump set starters shall incorporate the following protection features:
  - 34.4.7.1. Overload Trip.
  - 34.4.7.2. Overheat/Moisture Trip.
  - 34.4.7.3. Seal Failure  
Should features 12.4.7.1 or 12.4.7.2 occur a common trip signal shall be sent to the common control section. Indication on the starter section door shall indicate which trip feature has occurred. A common fault reset for features 12.4.7.1 and 12.4.7.2 shall be on the starter section door. A seal failure 12.4.7.3 shall not cause the starter to trip as it is used for indication only
  - 34.4.7.4. Should a failure occur in the level measuring device, then the appropriate alarms shall be flagged to telemetry.
- 34.5 Kiosk Door Open Contact
  - 34.5.1 Door opening detection using a lever arm type switch mounted on the door frame of the kiosk shall be provided.
  - 34.5.2 This switch shall be wired back to the telemetry rail.

## **35.0 ELECTRICAL INSTALLATION**

- 35.1 Installation of Equipment
  - 35.1.1 All equipment shall be securely mounted using proprietary fixtures and fittings in accordance with WIMES 3.02.
- 35.2 Installation of Cables
  - 35.2.1 Cables and cable support systems shall not be fixed to pump set guide rails.
  - 35.2.2 Joints shall not be permitted in individual power and control cables.
  - 35.2.3 Cables that may be subject to accidental mechanical damage shall be suitably protected.
  - 35.2.4 Ducts shall be provided for installation of the following:
    - 35.2.4.1. The electricity service provider incoming power cable. One duct shall be provided, sized according to the electricity service provider's requirements and routed between the point of supply / pumping site boundary and the kiosk plinth.
    - 35.2.4.2. The installation earth cable. One duct shall be provided, 50mm in diameter, routed between the point of supply and the kiosk plinth. One duct, 32mm in diameter between the wet well, the valve chamber and the flow meter chamber if applicable.
    - 35.2.4.3. The pump set cables. One duct shall be provided, 100mm in diameter, routed between the wet well, valve chamber and the kiosk plinth.
    - 35.2.4.4. The ultrasonic level sensor and float switch cables. One duct shall be provided, 100mm in diameter, routed between the wet well, valve chamber and the kiosk plinth.
    - 35.2.4.5. The telemetry aerial cable. One duct shall be provided and routed between the kiosk plinth and the 5-metre lighting column.
    - 35.2.4.6. The power cable for the wash water booster set. One duct shall be provided, 100mm diameter, routed between the main control panel kiosk and the wash water kiosk.
  - 35.2.5 Ducts shall consist of rigid black or grey uPVC pipe, complying with the relevant parts of BS 4660:2000, BS EN 1401-1:1998 and BS EN 1401 -1:2009.
    - 35.2.5.1. The duct for the electricity service provider's incoming power cable shall be black, embossed with the word 'ELECTRICITY' and may be flexible ribbed.
    - 35.2.5.2. Changes in direction of ducts shall be achieved using long radius bends.
    - 35.2.5.3. Ducts shall have self-aligning, watertight joints and a smooth internal bore.
    - 35.2.5.4. All accessories shall be proprietary and made from the same material as the duct.
  - 35.2.6 The ducts for the pump set cables shall enter the wet well near to its top so that the pump set cables can be easily reached from the top of the wet well.
  - 35.2.7 Ducts shall terminate approximately 75mm proud of the surface of the plinth.
  - 35.2.8 Depth of cover in soft ground shall be a minimum of 450mm above the crown of the duct.
  - 35.2.9 On completion, all ducts shall have a swab drawn through to clear them of obstructions.
  - 35.2.10 Ducts shall be left with an excess 1m length of 8mm diameter nylon drawcord in place, anchored at each end. This will be connected to a cable tie which will provide the necessary seal with the silicone-based sealant
  - 35.2.11 After installation of cables, all ducts shall be sealed with an approved, proprietary gas tight sealant.
  - 35.2.12 The duct leading to the telemetry antenna and the electricity service provider incoming duct may be

sealed with an expanding foam type sealant.

- 35.2.13 All ducts leading to and from the Wet Well shall utilise rubber insert sleeves around each cable for separation and as a backing for a high-quality silicone-based fire-resistant, water-repellent sealant. A typical sealing system is the Rise Duct Seal System from CSD sealing systems.
- 35.2.14 Conduit shall be provided for installation of the cables associated with the kiosk lighting systems, heating systems.
- 35.2.15 Conduit shall be manufactured from 20mm diameter, high impact resistance, heavy gauge u-PVC and comply with BS EN 61386-1:2004 and BS EN 61386-21:2004+A11:2010
- 35.2.16 The outside diameters of conduits and the dimensions of threads for conduits and fittings shall comply with BS EN 60423 :2007. All fittings shall be glued.

### 35.3 Glanding, Identification and Termination

- 35.3.1 Cable glands shall be selected, installed and inspected in accordance with BS 6121.-1:2005
- 35.3.2 All glands shall be suitable for the type of cable being installed and the intended operating environment.
- 35.3.3 Where cables could be subjected to a wet / damp environment, watertight seals shall be fitted on inner / outer sheaths.
- 35.3.4 All cable glands shall be fitted with an overall neoprene sealing sleeve.
- 35.3.5 Where a cable is glanded through a painted or otherwise coated metallic surface, provision shall be made to ensure earth continuity between the gland and the enclosure.
- 35.3.6 Glands shall be rigidly supported to ensure cable entry at right angles to the gland plate.
- 35.3.7 Cables and cores shall be identified at both ends by interlocking ferrules or another approved system.
- 35.3.8 Where provided, identification labels shall be legible, durable and securely affixed to the cable sheath by means of buckle type straps and shall carry the cable reference in PVC channel strip. The reference character sizes shall be not less than 3mm high.
- 35.3.9 All of the strands forming the conductor must be connected at the point of termination.
- 35.3.10 Wiring shall be terminated using crimped cable-ends or lugs which are suitable for the conductor and the type of termination, as recommended by the manufacturer.
- 35.3.11 For screened signal cables, screens shall be connected to earth using a proprietary 360° connection. The termination of screened signal cables shall comply with the Electrical Equipment (Safety) Regulations and the Electromagnetic Compatibility Regulations.
- 35.3.12 For screened signal cables, at the isolated end of the cable, a suitable length of the overall sheath and the screen shall be removed and a 30mm long silicone rubber over sleeve installed over the point of separation of conductors, screen and overall sheath.

### 35.4 Pump Controller

- 35.4.1 The level transducer shall be an ultrasonic device and associated level controller. This device shall maintain the Zone 2 classification of the wet well by use of an Ex-barrier if required. The ultra-sonic level transducer shall be mounted within the wet well on a hinged stainless-steel bracket in a suitable location which does not allow potential for damage during pump set removal/maintenance. The hinged bracket shall allow for maintenance of the transducer head at ground level without removal of the head from the bracket. The transducer cable shall be continuous back to the termination point in the control panel. The Ultrasonic transducer shall have facility to compute an optimal echo profile on installation to ensure accurate and reliable operation. All commissioning parameters surrounding the ultrasonic transmitter shall be recorded in the site Operation and Maintenance manuals.

### 35.5 High Level Float Switch Installation

- 35.5.1 A high level (overflow) alarm shall be provided by means of a non-mercury type float switch.
- 35.5.2 The float switch cable shall be continuous back to the termination point in the control panel.
- 35.5.3 The float switch shall be rated as a zone 2 device as a minimum specification.

### 35.6 Earthing and Bonding

- 35.6.1 All earthing and equipotential bonding shall be in accordance with: BS 7671 Regulations with particular reference to the recommendations of IEE Guidance Note 5: Protection Against Electric Shock (latest Edition); BS 7430:2011; the Electricity Supply Regulations; electricity service provider; and G59 Engineering Recommendations.
- 35.6.2 A main copper earth bar (minimum size 25 x 3mm thick) shall be located on the wooden backboard of the kiosk.
- 35.6.3 A main earth conductor shall be installed from the main earth bar to:
  - 35.6.3.1. electricity service provider's connection.
  - 35.6.3.2. copper earth electrodes.
  - 35.6.3.3. main incoming earth terminal in the electrical control panel.
- 35.6.4 A main equipotential bonding conductor shall be installed from the main earth bar to:
  - 35.6.4.1. Metal casing of the electrical control panel.
  - 35.6.4.2. Metal support frames of any electrical equipment.
  - 35.6.4.3. Pipework in the wet well and valve chamber.
  - 35.6.4.4. All and any exposed metalwork.
- 35.6.5 All metalwork shall be cross-bonded for earth continuity.
- 35.6.6 To facilitate any future emergency connection of a portable generator an external spike in a toby box



shall be provided and labelled 'Safety Electrical Earth – Do Not Remove'. An impedance value of no greater than 20 ohms is required. Tested value to be recorded on the valid Electrical Installation Test Certificate, provided to NI Water with the O & M manual.

- 35.6.7 Sizing or earthing, bonding conductors and earth electrodes shall be in accordance with the current edition of the BS 7671 Regulations.

## **PART D – VALVE SPECIFICATION**

### **36.0 Introduction**

- 36.1 This specification defines the requirements for valves for use in wastewater pumping stations for the Water Industry.

### **37.0 Gate (Sluice) Valves**

- 37.1 Gate valves shall comply with BS 5150 and incorporate non-rising valve spindles. The inlet and outlet connections of the valves shall terminate with flange type PN16 (minimum), as detailed in BS 4504: Part 3.
- 37.2 Gate valves shall be fitted with removable cast iron hand wheels, which shall have the direction of opening / closing of the valve clearly and indelibly marked on their surface.
- 37.3 Horizontally mounted valves shall be provided with extension spindles, headstocks and support brackets, if the valve chamber is greater than 1200mm in depth. Spindles shall extend to approximately 50mm below the underside of the access cover, so that valves can be opened / closed from above ground using 'T' keys, which shall be supplied by the Developer.
- 37.4 Gate valves shall be designed to close when hand wheels / 'T' keys are rotated in a clockwise direction.

### **38.0 Check (Reflux) Valves**

- 38.1 Check valves shall comply with BS 5153 and be of the swing type fitted with external lever arms and counterweights. The inlet and outlet connections of the valves shall terminate with flange type PN16 (minimum), as detailed in BS 4504: Part 3. All lever arm / counterweight assemblies shall be guarded.
- 38.2 Check valves shall be designed and sized to close rapidly without shock and have good seating properties.
- 38.3 Check valves shall be non-clogging. The valve design shall ensure that, when the valve disc is in the fully open position, the size and direction of the flow path is equivalent to that of the surrounding pipework. The valve internals (seat, disc, etc.) shall be arranged so that there are no projections that could interfere with the passage of solids, rags and fibrous materials.
- 38.4 Check valves shall be provided with removable covers, sized to allow adequate access to the valve internals (seats, discs, hinges etc.).

### **39.0 Maintenance/Operational Issues**

- 39.1 All equipment within the valve chamber shall be arranged / positioned to allow adequate access for maintenance. Particular attention shall be paid to the following:
  - 39.1.1 The clearance around check valves, to enable removal of the disc hinge pins.
  - 39.1.2 The clearance between the invert of the valve chamber pipework and the valve chamber finished floor level (minimum of 300mm).
  - 39.1.3 The clearance between flanged connections and surrounding equipment / structures (minimum of 300mm).
- 39.2 Flange adapters shall be provided, where appropriate, to facilitate valve removal and replacement. These shall be tied to the flanges of adjacent pipework to prevent movement of the joint during operation.
- 39.3 An automatic wet well flushing system shall be provided. As specified by NI Water, this shall comprise of a hydraulically actuated flushing valve fitted to one of the pump sets.

### **40.0 Miscellaneous**

- 40.1 ½ inch BSP tappings suitable for the attachment of pressure gauges shall be made in the pipework immediately before and after all check valve / gate valve combinations. All tappings shall be plugged.
- 40.2 The pipework between the wet well and valve chamber shall be fitted with flexible pipe couplings to accommodate differential movement between the two structures.

## PART E - TELEMETRY SPECIFICATION

### 41.0 Telemetry Installation & Configuration

- 41.1 This section defines the requirements for telemetry equipment forming part of two-pump pumping stations for use within NI Water.

### 42.0 General

- 42.1 The Developer / Contractor shall supply, install and commission all equipment necessary to permit remote monitoring of the site on the NI Water Regional telemetry system. NI Water will require the telemetry outstation to communicate with the NI Water telemetry system via a digital radio. In extenuating circumstances, NI Water may consider the use of other forms of telecommunications.
- 42.2 The complete on-site telemetry installation and commissioning will require liaison with  
Northern Ireland Water  
ICT Telemetry Centre  
email: [telemetrydevelopment@niwater.com](mailto:telemetrydevelopment@niwater.com)
- 42.2.1 A telemetry outstation (see note under 22.0).
- 42.2.2 Communications Modem: Digital Radio.
- 42.2.3 Suitable antenna pole for Digital Radio.
- 42.2.4 Appropriate antenna and coaxial cabling for Digital Radio.
- 42.2.5 All liaison with relevant NI Water personnel.

### 43.0 Selection of Communications Modem

- 43.1 The selection of the appropriate communications modem shall be decided in consultation with the NI Water ICT Telemetry Centre.
- 43.2 Developers / contractors shall contact the NI Water ICT Telemetry Centre at Bretland House to ensure the necessary procedures are followed. It is suggested this is undertaken at the earliest possible stage of the project to avoid delays.
- 43.3 The preferred NI Water Telemetry communications methodology utilises a digital radio modem via a licensed digital radio path. To ascertain if this methodology is viable a digital radio path profile must be undertaken by the NI Water ICT Telemetry Centre.
- 43.3.1 The following information must be supplied to the NI Water ICT Telemetry Centre.
- 43.3.2 Site Name.
- 43.3.3 Site Grid reference: (taken from proposed position of telemetry antenna).
- 43.3.4 Site specific information of any impediment to radio propagation from site to proposed radio scanner, including photographs.
- 43.4 Upon a satisfactory path profile and relevant site information being provided a radio path license application will be submitted.
- 43.5 The lead in time for this application and resultant reply will be in the region of 4 to 6 weeks.
- 43.6 As part of the adoption procedure and or site commissioning the developer / contractor will produce written documentation from NI Water ICT Telemetry Centre specifying the agreed choice of communications modem outcome.
- 43.7 This outcome will specify the following:
- 43.7.1 Documentation from NI Water ICT Telemetry Centre, specifying the communications method.
- 43.7.2 The following documentation will be provided by NI Water Telemetry Centre, to the requesting Developer / contractor, and must be included in the Site Operations and maintenance manual.
- 43.7.2.1 A copy of the NI Water radio path profile and power loss in dB.
- 43.7.2.2 A copy of the licensing authority radio path profile and radio transmit power.
- 43.7.2.3 The selected radio telemetry scanner and associated radio channel.
- 43.7.2.4 The azimuth from the Wastewater Pumping Station Site to the scanner.
- 43.7.2.5 The telemetry outstation set number.
- 43.7.2.6 The telemetry outstation number.
- 43.7.3 In exceptional circumstances, where a licensed radio path is not available then the developer must make early contact with NI Water ICT telemetry centre to approve an alternative communications methodology.

### 44.0 Telemetry Outstation

- 44.1 T Build T4e-0.75E  
110/230VAC powered Talus T4e outstation with Proteus or WITS software, fitted with 20x DI, 4x AI, 6x DO, 2x auxiliary inputs, 2x RS232 and 2x RS485 serial ports, Ethernet 4x 10/100 Base-T, Wireless GSM / GPRS MODEM +PSTN, 120W PSU, 2x 7Ah Batteries, fuses, marshalling terminals, MCBs, trunking, fully wired and tested fitted on a back plate and inside an enclosure 500mm x 500mm x 250mm (W x H x D).

Radio mounting bracket (fitted) and space for Aprisa SRX radio (to be supplied and fitted by others). Space is to be available on the back-plate to add I/O modules in the future.

- 44.2 Talus supplier contact details:  
[Schneider Electric UK | Energy Management and Automation \(se.com\)](#)

- 44.3 A Telemetry Outstation shall be mounted on the wooden backboard of the kiosk adjacent to the control panel. The mains supply to the outstation shall be derived from the control panel.
- 44.4 To be compatible with NI Water Telemetry system, the outstation shall be purchased from the relevant NI Water Telemetry Outstation Framework.
- 44.5 Details reference the outstation model and supplier framework can be obtained from NI Water ICT Telemetry Centre, Westland House.
- 44.6 The outstation shall be supplied and configured with the appropriate communications modem and standby battery capable of supporting the outstation for 4 hours. This battery is normally supplied, on request, by the outstation supplier.
- 44.7 The signals from the outgoing terminal rail in the common control section of the control panel shall be wired to the telemetry outstation using 5 pair Belden cable, or equivalent.

#### **45.0 Telemetry Configuration**

- 45.1 Telemetry configuration is undertaken by the NI Water ICT Telemetry Centre Configuration of the Talus T4e needs to be arranged between the developer and the NI Water Telemetry Centre at Westland House. This will require the Talus T4e to be issued to the Telemetry Centre for pre-configuration. Commissioning should be arranged between the Developer and NI Water ICT Telemetry Centre. The developer is advised that the Talus T4e pre-configuration of the outstation is completed by NI Water ICT Telemetry Centre 6 weeks prior to the planned commissioning date. All signal configurations including alarm levels must be completed on this pro forma.
- 45.2 Failure to do so will result in non-configuration, non-commissioning and subsequent non-adoption of the site.

#### **46.0 Telemetry Digital Radio**

- 46.1 The digital radio shall be mounted adjacent to the Pump Controller or within the outstation. To be compatible with NI Water telemetry system, the digital radio is currently an Apraisa 4RF digital radio and are available from  
Telent Technology Services Ltd  
[Keeping the UK & Ireland's Communications Assets & Data Connected & Protected - Telent Contact Us via Telephone, Email or Submit a Form - Telent](#)

#### **47.0 Telemetry Aerial Pole**

- 47.1 The Developer shall supply a 5 metre, or greater if required, standard street lighting column complete with end cap. The lighting column shall be installed optimally on site for radio signal propagation i.e. avoiding obstructions such as buildings, trees, high voltage power lines, transformers etc. and as close to the kiosk as possible. Ducting shall be installed from the column to the kiosk. If the street lighting column is greater than 5m high, then the Developer shall obtain planning permission from the appropriate planning office.

#### **48.0 Telemetry Aerial**

- 48.1 The aerial shall be mounted on top of the lighting column using suitable fixings to allow for full adjustment in any direction at the commissioning stage. The co-axial aerial feeder shall be one autonomous length, i.e. without joints, and be wired back, through ducting, and connected to the radio within the kiosk either to the pump controller or the telemetry outstation.
- 48.2 To be compatible with NI Water telemetry system, the aerial shall be a 12-element Yagi antenna, to operate at 450-470 MHz
- 48.3 Digital radio set up, antenna installation and commissioning shall be undertaken by qualified and competent radio engineers to ensure the site communication characteristics are optimal. A Certification of Competence for the engineers, on site, will be required by the NI Water ICT Telemetry Centre, prior to commissioning being undertaken.

#### **49.0 Commissioning of Telemetry System**









- 49.1 Installation and commissioning of the outstation shall be undertaken by qualified and competent radio engineers to ensure the site communication characteristics are optimal. A Certification of Competence for the engineers, on site, will be required by the NI Water ICT Telemetry Centre prior to commissioning being undertaken.
- 49.2 Failure to comply with these procedures may result in NI Water completing the work and recovering the costs from the Developer under due process.

## PART Of ASSET DATA CAPTURE (BUDI Return)

### 50.0 Introduction

50.1 Assets within the Wastewater Pumping Station are to be recorded by the Developer or the M&E contractor and returned to the NI Water Asset Information Maintenance Team. All asset data submitted as part of a BUDI return can be identified as per 'C001 COP for Submitting Asset Records' and all assets are required to be tagged as per 'The C003 Asset Tagging Guidelines', which will be supplied with the contractor packs upon request from [Asset.Information@niwater.com](mailto:Asset.Information@niwater.com).

### TYPICAL M&E DRAWINGS – Appendix C

<b>NIW WWPS 04</b>	NIW Typical Standard Panel Layout	
<b>NIW WWPS 05</b>	NIW Typical Standard Panel Control Section	
<b>NIW WWPS 06</b>	NIW Typical Standard Panel Mains Section	
<b>NIW WWPS 07</b>	NIW Typical Standard Panel Starter Section Grundfos ASD	
<b>NIW WWPS 08</b>	NIW Typical Standard Panel Starter Section Grundfos DOL	
<b>NIW WWPS 09</b>	NIW Typical Standard Panel Starter Section Xylem ASD	
<b>NIW WWPS 10</b>	NIW Typical Standard Panel Starter Section Xylem DOL	
<b>NIW WWPS 11</b>	NIW WWPS 11 Pumping Station Kiosk Detail DRP 1000a	

## APPENDIX A - NIW SITE SIGNAGE REQUIREMENTS

### Specification for Small and Medium Signs

#### PLEASE NOTE : NO SIGNAGE IS TO BE FITTED PRIOR TO THE FORMAL FINAL ADOPTION HANDOVER

- All signs shall comply with the requirements of the current Northern Ireland Water Brand guidelines, available on request from [CustomerEngagementTeam@niwater.com](mailto:CustomerEngagementTeam@niwater.com). Particular note should be paid to the typefaces and colours used
- Sign to be 3mm thick aluminium sign with exterior grade digital printing (flat print) with clear anti-vandal over laminate (non reflective). Dye bonded or other composite material is not acceptable.
- Signs to be provided as a medium sized sign = 600 x 450mm.
- An example of a medium sign to be provided is shown below with the required measurements and text sizes. Please note logo positions etc are not to be changed.
- One sign is to be supplied for inspection and acceptance prior to manufacturing complete sign schedule. Signs provided for acceptance will be fitted on site provided they are found acceptable and **only to be fitted on the day of Adoption Handover.**
- The required sign and fixing details for each particular site are to be advised by a separate sign schedule.
- Wall mounted signs are to be supplied with 4 nr fixing holes and to be fixed to wall at agreed position by contractor on site. Redundant signs/posts/fixings to be removed off site.
- Fence or gate mounted signs are to be supplied with 2 nr aluminium mounting plates/strips complete with stainless steel bolts, washers and lock nuts.
- Pole mounted signs (ie 600 x 450mm Signs) are to be supplied with aluminium back track complete with 2 nr 75mm stainless steel clips, bolts, nuts and washers. Back track to be fixed to sign with 3M adhesive tape in accordance with manufacturers instructions/recommendations.
- Medium sized signs are to be supported by 1 nr 75mm dia galvanised post 2400mm long fitted with a 150mm square base plate and plastic cap on top. The sign shall be erected at a height of 1200mm from ground level to the bottom edge of the sign. Postholes shall measure 600mm square x 850mm deep. The posts shall be set centrally in the holes to a depth of 750mm, with the holes backfilled with grade C20 concrete to ground level and “weathered” on top to prevent water ponding. Concrete to be adequately compacted.

Dunmurry has been illustrated as an example but this design can be applied to any wastewater base maintenance pumping station. Please get the sign maker to apply the relevant site name and CAR ID.

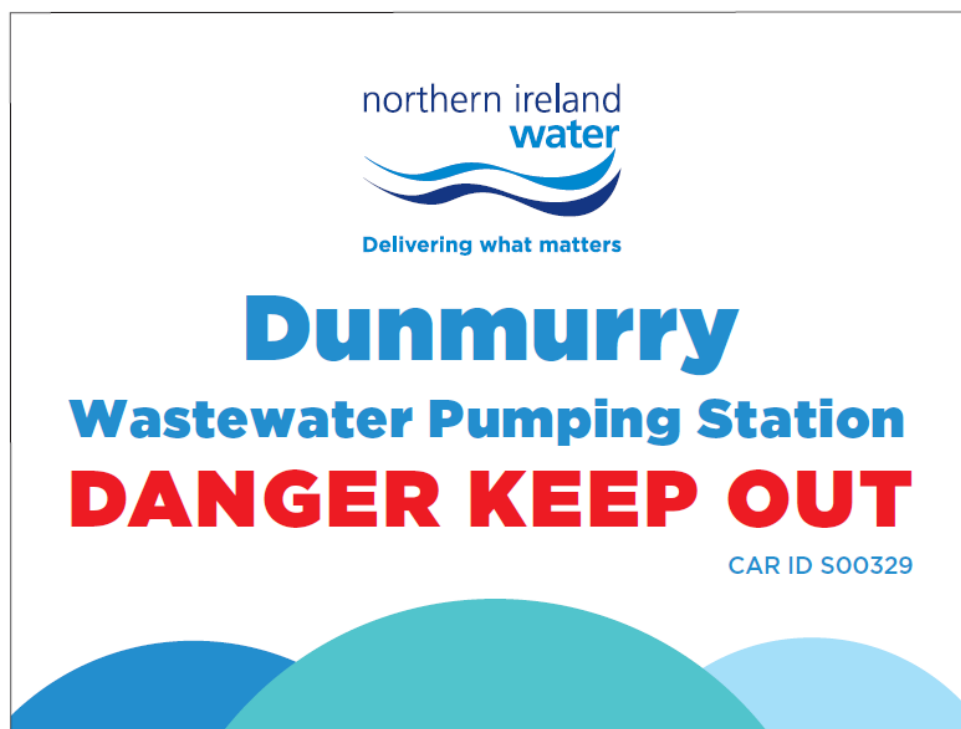

Medium sign 600 x 450mm

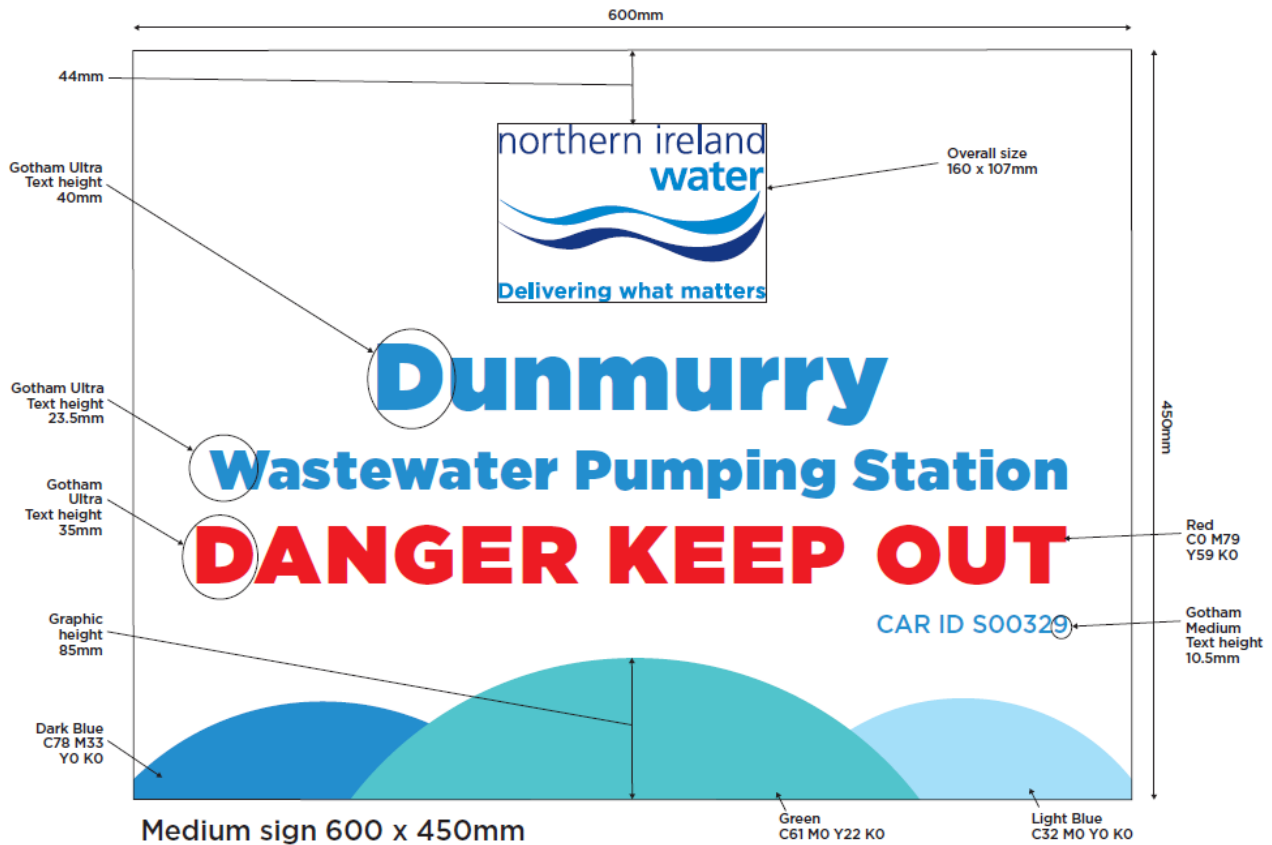

### Signage Colour palette

Colours are very important to us. We have carefully selected the ideal colours and tones to complement and enhance our brand. The pastel blues and aquatic greens work with our graphic style to create a sense of friendliness and approachability.

You can see the breakdown options here for CMYK.

These are our core brand colours and it's important we use them throughout our signage materials.

### CMYK



C78 M33 Y0 KO



C61 M0 Y22 KO



C32 M0 Y0 KO



CO M79 Y59 KO

### Signage Typography

#### Print

The Northern Ireland Water typeface for signage is Gotham Ultra (main text). Gotham Medium is used only for the CAR ID number

#### Typeface

**Gotham Ultra**

Gotham Medium

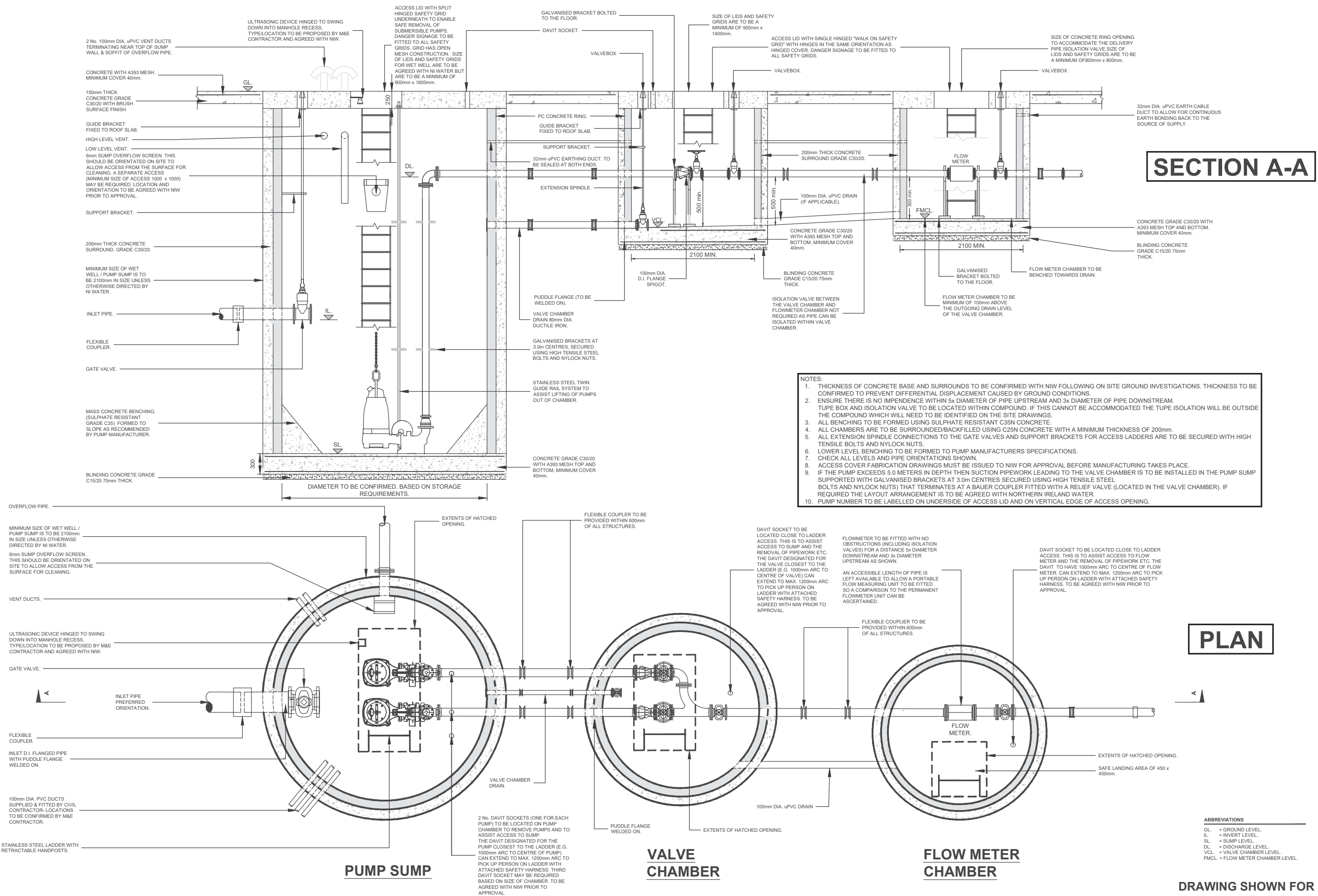

TYPICAL ARRANGEMENT OF A WET WELL SUBMERSIBLE PUMPING STATION, VALVE CHAMBER AND FLOWMETER CHAMBER - NIW Reference: NIW-WWPS01

**DRAWING SHOWN FOR INDICATION PURPOSES ONLY. NOT TO SCALE, DIMENSIONS IN MILLIMETERS.**



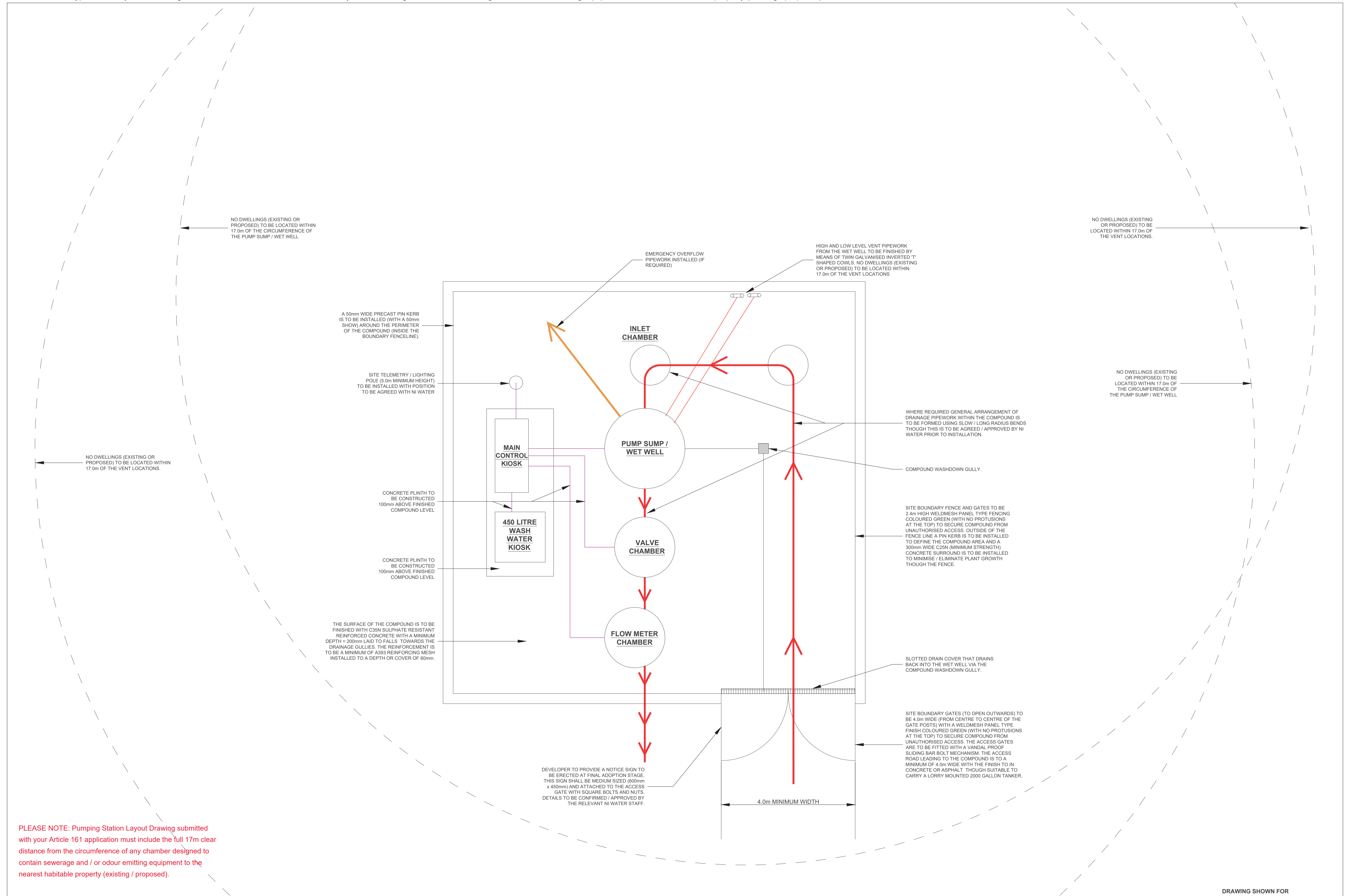

PLEASE NOTE: Pumping Station Layout Drawing submitted with your Article 161 application must include the full 17m clear distance from the circumference of any chamber designed to contain sewerage and / or odour emitting equipment to the nearest habitable property (existing / proposed).

TYPICAL ARRANGEMENT OF A PUMPING STATION (FOUL OR STORM) COMPOUND PLAN - NIW Reference: NIW-WWPS02

DRAWING SHOWN FOR INDICATION PURPOSES ONLY. NOT TO SCALE, DIMENSIONS IN MILLIMETERS.

# 500KG WLL (Working Load Limit) FLUSH MOUNT GALVANISED DAVIT SOCKET

Suitable for a Davit Arm with a kingpin / spigot that can fit a socket with a 65mm Diameter

### COVER PLATE

PROVIDED THE COVER PLATE HAS AN ATTACHED SPIGOT (AS SHOWN) THERE WILL BE NO REQUIREMENT FOR THE PLATE TO BE HELD IN PLACE TO THE DAVIT SOCKET WITH COUNTERSUNK SCREWS

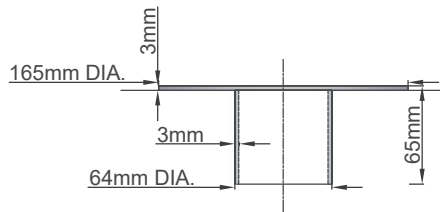

TOP FLANGE COVER IS LEVEL WITH GFL. 3MM COVER PLATE SITS PROUD

**COVER PLATE & SPIGOT SECTION**

### DAVIT SOCKET

(RESIN BOND VERSION). SUITABLE FOR A DAVIT ARM WITH A SPIGOT THAT CAN FIT A SOCKET WITH A 65MM DIAMETER

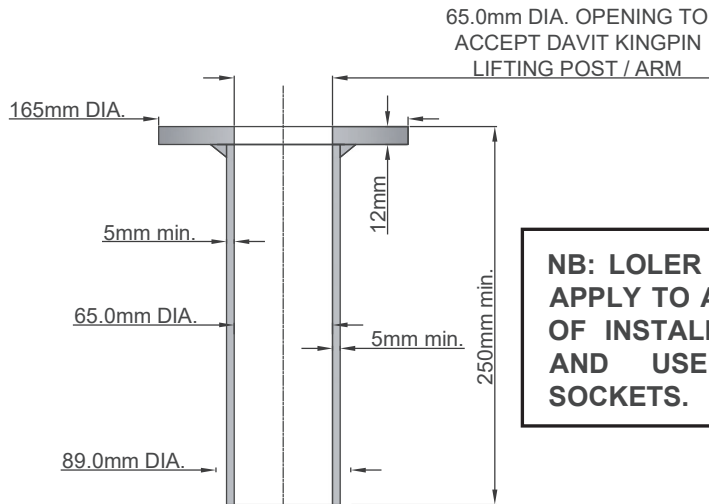

65.0mm DIA. OPENING TO ACCEPT DAVIT KINGPIN LIFTING POST / ARM

**NB: LOLER REGULATIONS APPLY TO ALL ELEMENTS OF INSTALLING, TESTING AND USE OF DAVIT SOCKETS.**

**DAVIT SOCKET SECTION**

### DAVIT SOCKET

VIEW FROM ABOVE DAVIT SOCKET SHOWS THE LOCATION OF THE DRAIN HOLES IN THE BASE TO ALLOW WATER TO DRAIN.

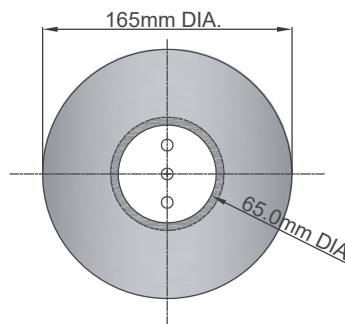

**PLAN VIEW**

**NB: ON CERTAIN OCCASIONS THE DAVIT SOCKETS MAY NEED TO BE FABRICATED IN STAINLESS STEEL. CONFIRMATION IS TO BE SOUGHT FROM NI WATER PRIOR TO INSTALLATION**

### NOTES:

WHEN FIXING SOCKETS TO STRUCTURES, CUSTOMERS MUST ALWAYS SEEK THE GUIDANCE OF A SUITABLY QUALIFIED ENGINEER TO ENSURE THAT THE STRUCTURE IS ABLE TO SUPPORT THE REQUIRED LOADS AND HOW THE FIXING RESIN SHOULD BE USED TO ANCHOR THE DAVIT SOCKET TO THE PREVIOUSLY INSTALLED CONCRETE SLAB.

THE DAVIT SOCKET IS TO BE INSTALLED FLUSH WITH GROUND LEVEL TO PREVENT TRIP HAZARDS AND ALSO ALLOW THE DAVIT TO ROTATE FULLY WITHOUT THE BASE PLATE FOULING UNDER LOAD. THE NORMAL AND PREFERRED OPERATING DIAMETER FROM THE CENTRE OF THE LOAD TO THE DAVIT SOCKET IS 1000MM (THE DISTANCE CAN BE BETWEEN 800MM AND 1200MM ONLY BY PRIOR APPROVAL OF THE APPROPRIATE NI WATER STAFF). THE DAVIT ARM SUPPORT TUBE SHOULD NOT FOUL WITH COVER LIDS OR SAFETY GRIDS IN NORMAL OPERATION.

### NOTES CONTD.:

THE DAVIT SOCKETS AFTER A REASONABLE SETTING PERIOD MUST BE LOAD TESTED, CERTIFIED AND PLATED BEFORE USE. THE ID PLATE (INCLUDING A SMALL EYEHOLE TO SECURE AN INSPECTION TAG WITH A 6MM CABLE TIE) IS TO ALUMINIUM OR STAINLESS STEEL, HARD STAMPED / PERMANENTLY MARKED AND FIRMLY SECURED WITH THE MANUFACTURERS OR INSTALLERS NAME, SAFE WORKING LOAD (OR WORKING LIVE LOAD), THE DATE OF INSTALLATION OR LOAD TEST (TO MATCH THE CERTIFICATE) AND A UNIQUE ID NUMBER TO MATCH THE SITE AND FINAL LOAD TEST (WITH PASS OR FAIL RECORDED ON THE CERTIFICATE) WILL BE REQUIRED. THE PROOF LOAD APPLIED WILL BE NO LESS THAN 625 KG FOR A 500 KG SOCKET (NB: THIS ONLY TAKES PLACE AFTER FIRST INSTALLATION).

NB: SIMILAR TO DAVIT SOCKETS THE STAINLESS STEEL PUMP CHAINS AND LOCKABLE STAINLESS STEEL SHACKLES WHERE FITTED ARE REQUIRED TO HAVE A UNIQUE IDENTIFYING NUMBER ON AN ID PLATE FITTED AT THE TOP END WITH SIMILAR MARKINGS.

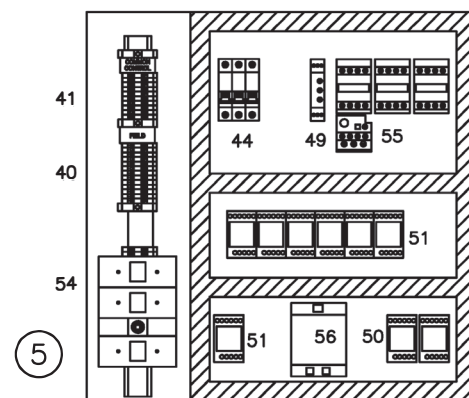
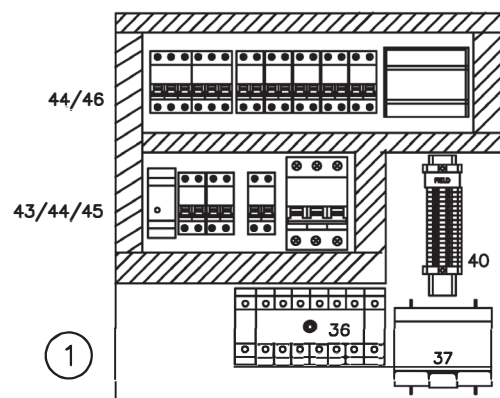
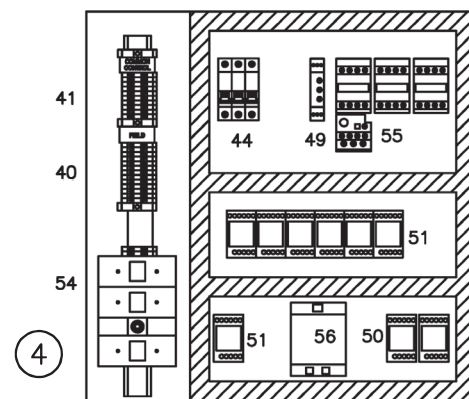
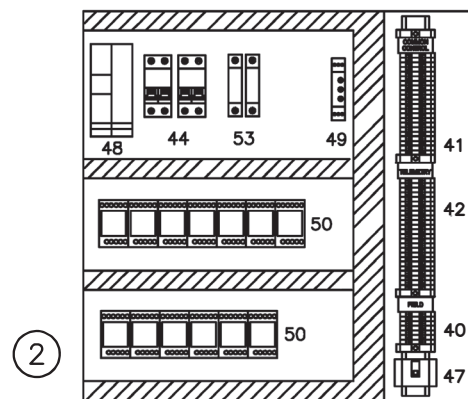
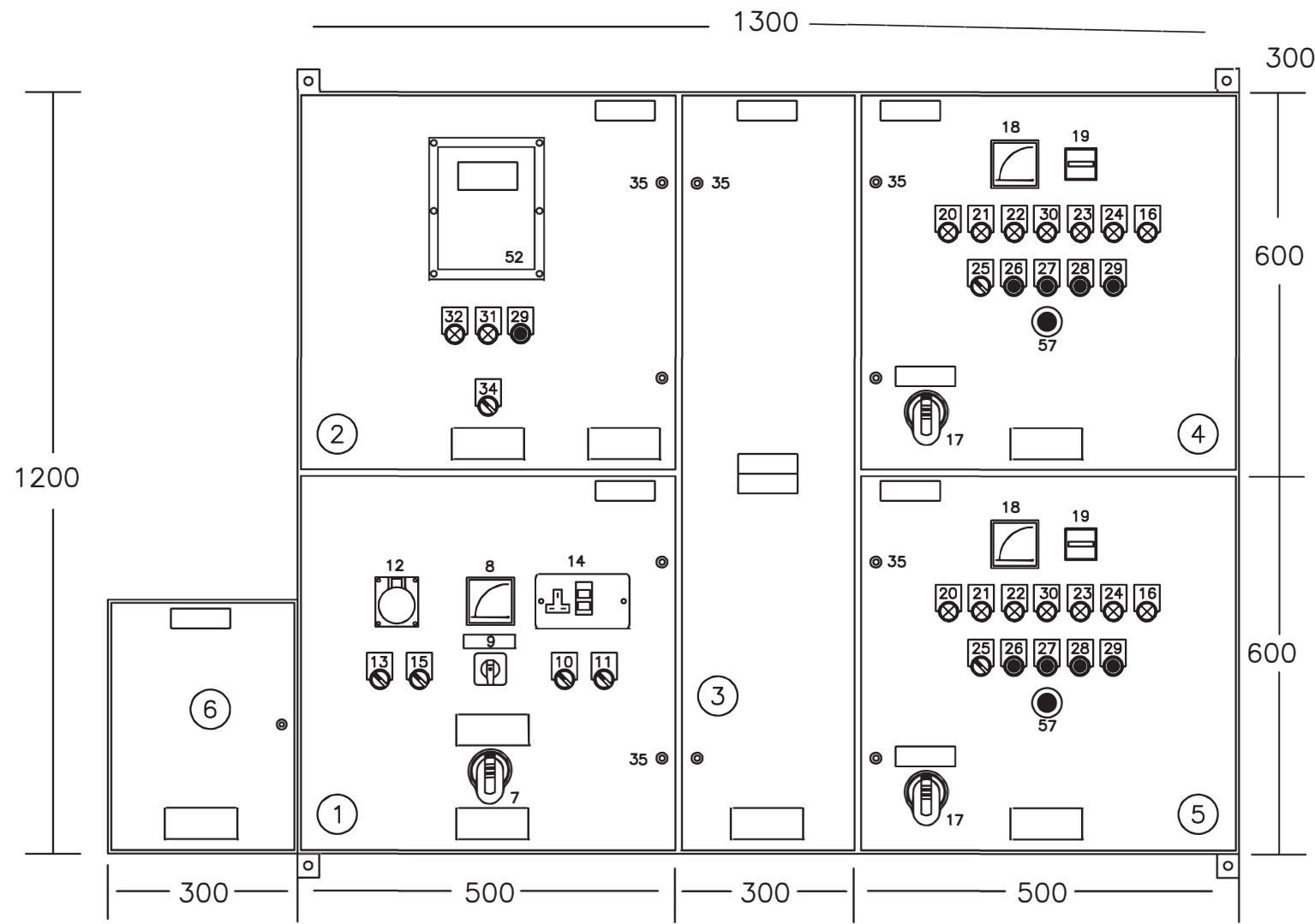

ITEM No.	DESCRIPTION
1	MAINS AND DISTRIBUTION SECTION
2	COMMON CONTROL SECTION
3	CABLE COMPARTMENT
4	SUBMERSIBLE PUMP MOTOR STARTER No.1
5	SUBMERSIBLE PUMP MOTOR STARTER No.2
6	GENERATOR CONNECTION BOX (SEE NOTE)
7	DOOR INTERLOCKED 3 POSITION SWITCH (GENERATOR – OFF – MAINS )
8	VOLTMETER 0–500V (72X72MM)
9	VOLTMETER SELECTOR SWITCH
10	SELECTOR SWITCH 2–POSITION (ON/OFF KIOSK HEATER)
11	SELECTOR SWITCH 2–POSITION (ON/OFF KIOSK LIGHT)
12	SOCKET OUTLET 110V (YELLOW)
13	SELECTOR SWITCH 2–POSITION (ON/OFF 110V SOCKET)
14	SWITCHSOCKET OUTLET 13 AMP 30mA RCD PROTECTED
15	SELECTOR SWITCH 2–POSITION (ON/OFF SITE LIGHTING)
16	INDICATING LAMP 230V RED LED 30mm DIA (EMERGENCY STOP ACTIVATED)
17	DOOR INTERLOCKED SWITCHFUSE
18	AMMETER (72x72mm)
19	HOURS RUN METER (230V)
20	INDICATING LAMP 230V AMBER LED 30mm DIA (AUTO AVAILABLE)
21	INDICATING LAMP 230V GREEN LED 30mm DIA (RUNNING)
22	INDICATING LAMP 230V RED LED 30mm DIA (OVERLOAD TRIP)
23	INDICATING LAMP 230V RED LED 30mm DIA (MOTOR OVERHEAT/MOISTURE)
24	INDICATING LAMP 230V RED LED 30mm DIA (SEAL FAILURE)
25	SELECTOR SWITCH 3–POSITION 2–POLE (HAND–OFF–AUTO) TELEMECANIQUE
26	PUSHBUTTON GREEN (START) TELEMECANIQUE
27	PUSHBUTTON RED (STOP) TELEMECANIQUE
28	PUSHBUTTON BLUE (FAULT RESET) TELEMECANIQUE
29	PUSHBUTTON BLUE ( LAMP TEST ) TELEMECANIQUE
30	INDICATING LAMP 230V RED LED 30mm DIA (FAIL TO START)
31	INDICATING LAMP 24V RED LED 30mm DIA (ULTRASONIC FAULT LOSS OF ECHO)
32	INDICATING LAMP 24V RED LED 30mm DIA (PUMP SUMP HIGH LEVEL ALARM)
33	
34	SELECTOR SWITCH 3–POSITION 2–POLE (DUTY SELECTOR) TELEMECANIQUE
35	ENCLOSURE LOCK.
36	MAINS/GENERATOR CHANGEOVER LOADBREAK SWITCH ( ABB )
37	630VA 230/55–0–55V TRANSFORMER
38	
39	
40	FIELD TERMINAL BLOCK
41	COMMON CONTROL TERMINAL BLOCK
42	TELEMETRY TERMINAL BLOCK
43	LOAD SUPPLY MAIN MCB MERLIN GERIN
44	CONTROL MCB'S
45	PHASE FAILURE RELAY (TELEMECANIQUE)
46	TP+N MAINS DISTRIBUTION BLOCK
47	TOGGLE LOADBREAK SWITCH
48	24VDC POWER SUPPLY
49	DELAY ON CONTROL TIMER (CARLO GAVAZZI)
50	24VDC 3POLE CONTROL RELAYS (TELE)
51	230VAC 2POLE CONTROL RELAYS (TELE)
52	ULTRASONIC SUMP LEVEL CONTROLLER
53	DC CONTROL FUSES
54	DOOR INTERLOCKED SWITCH FUSE
55	AUTOMATIC STAR DELTA STARTER C/W O/LOAD PROTECTION
56	GRUNDFOS PUMP PROTECTION / MONITORING RELAY
57	EMERGENCY STOP PUSHBUTTON (TELEMECANQUE)

NIW WWPS 05 NIW Typical Standard Panel Control Section

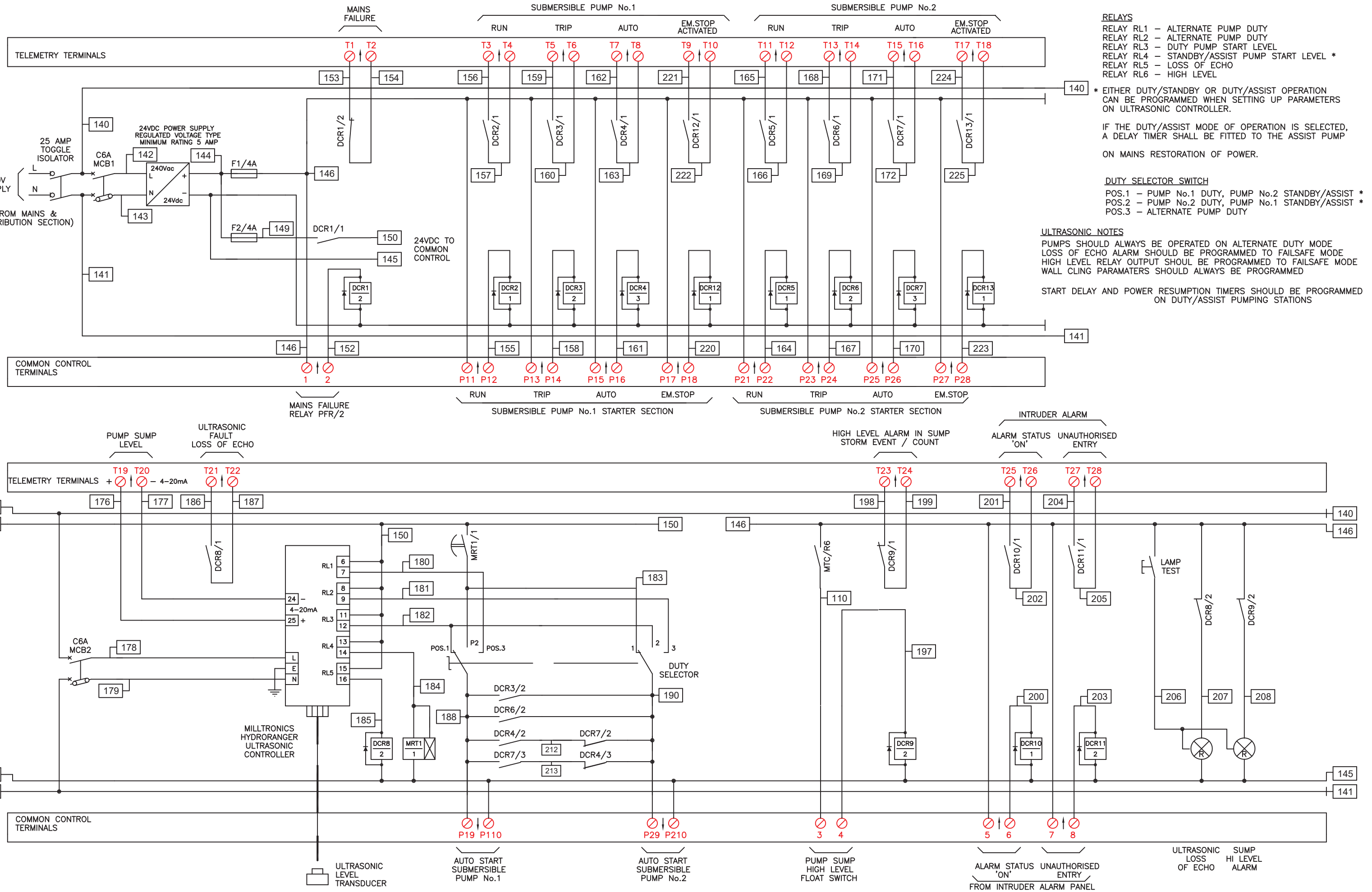

NIW WWPS 06 NIW Typical Standard Panel Mains Section

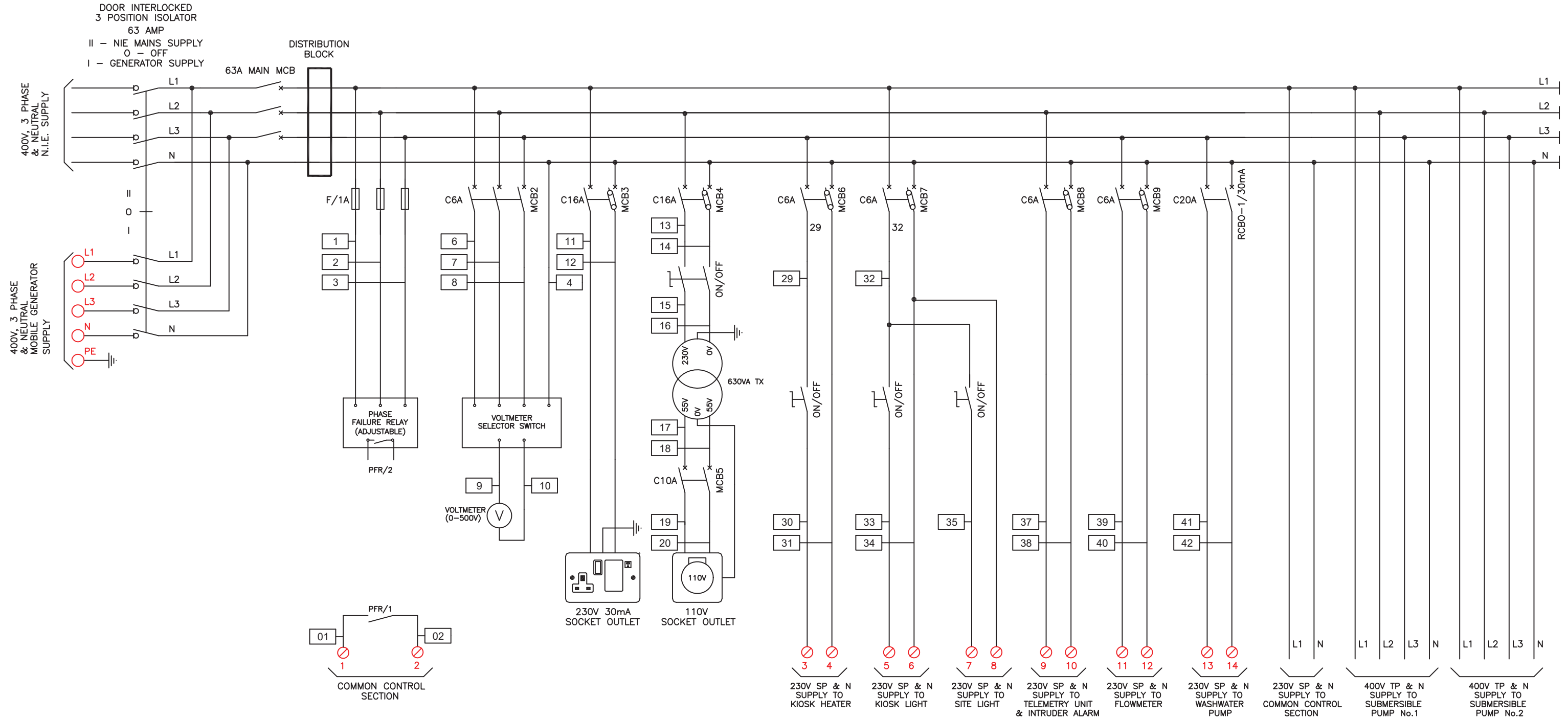

# PUMP GRUNDFOS ASD

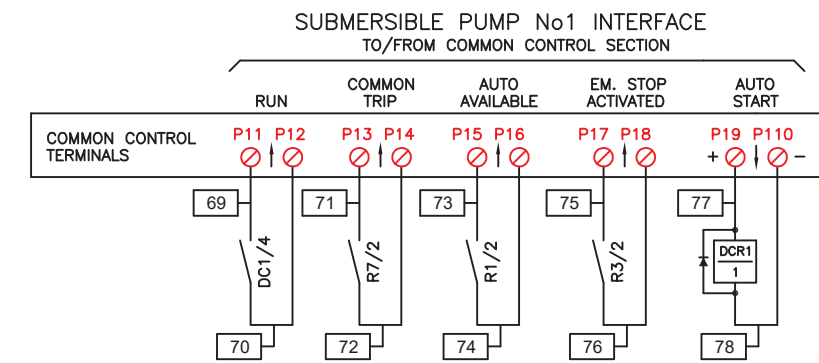
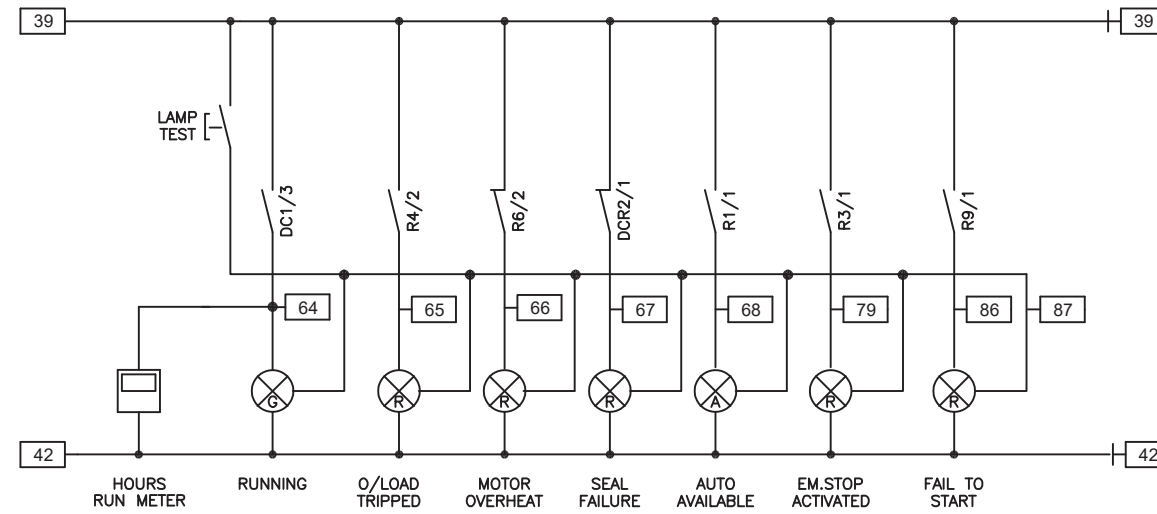
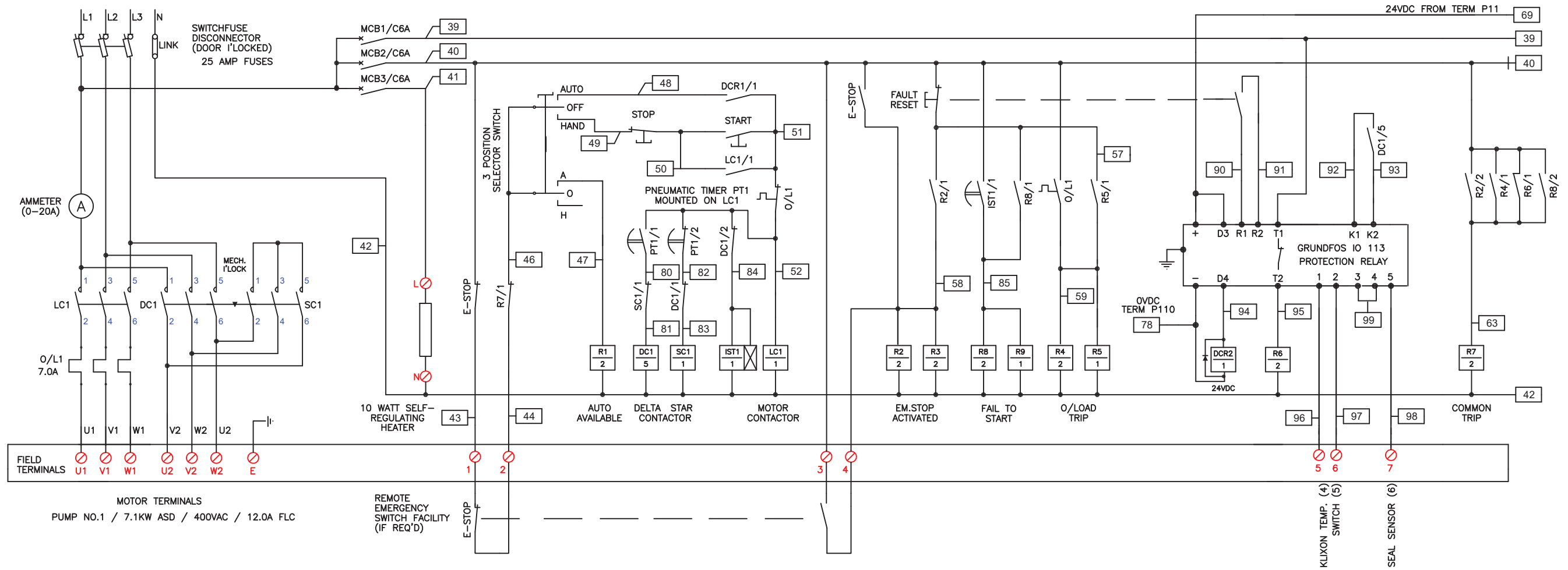

# PUMP GRUNDFOS DOL

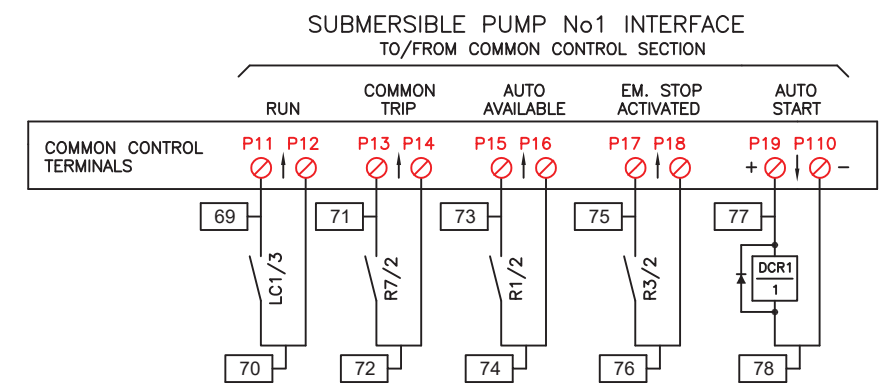
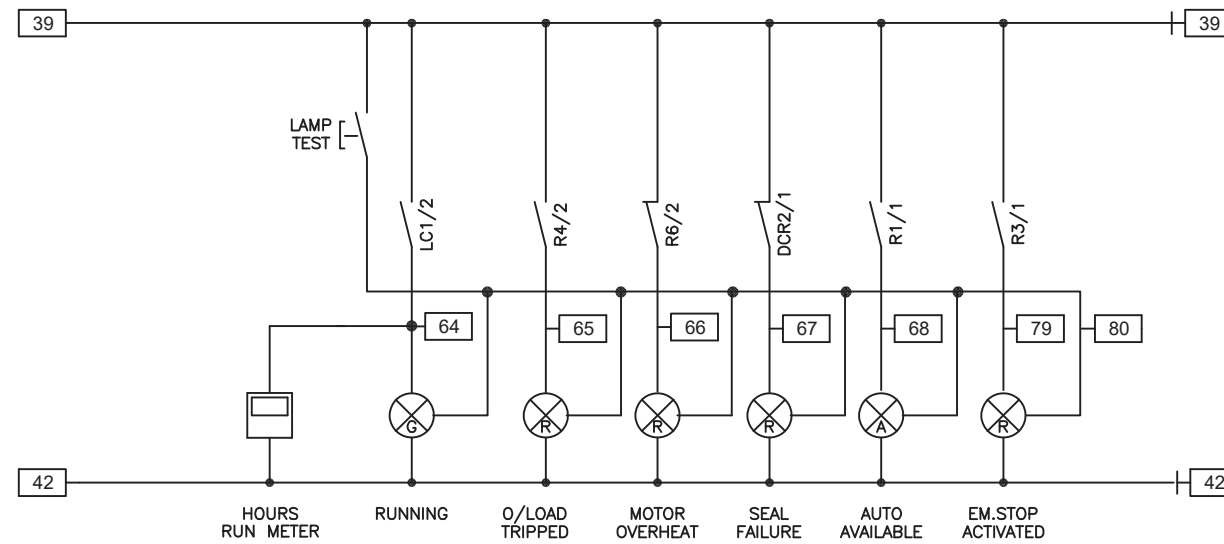
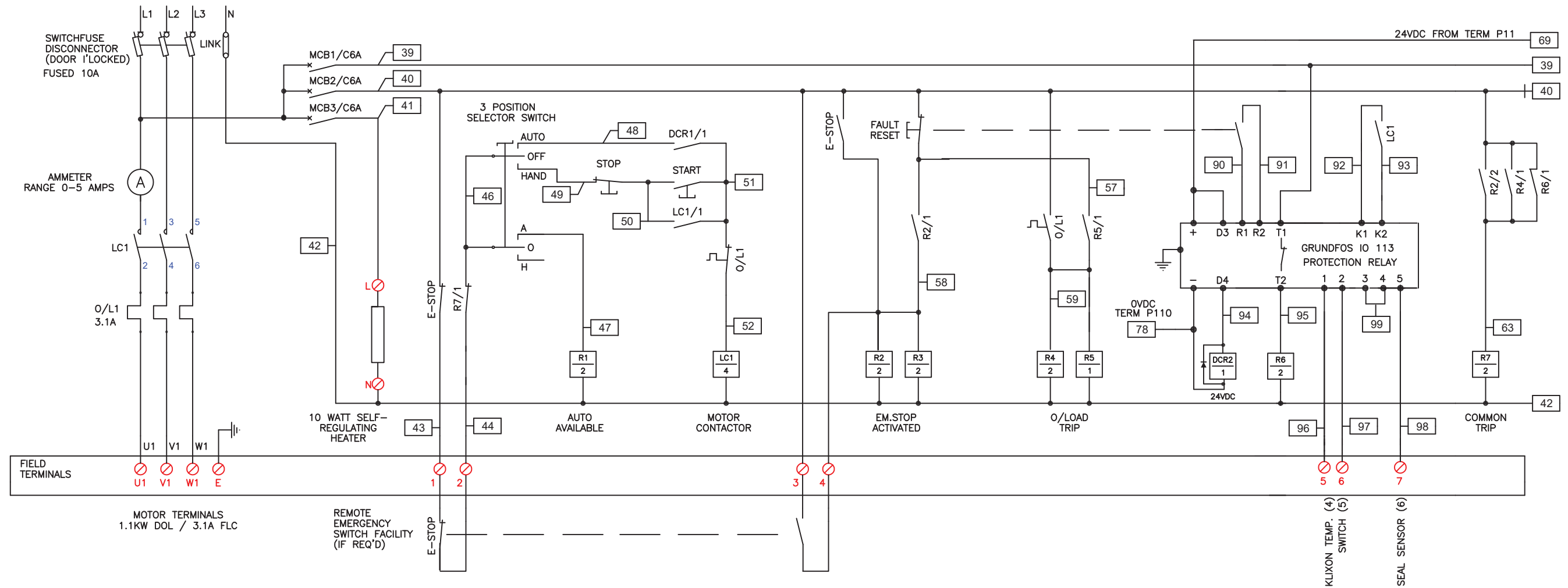

# PUMP XYLEM ASD

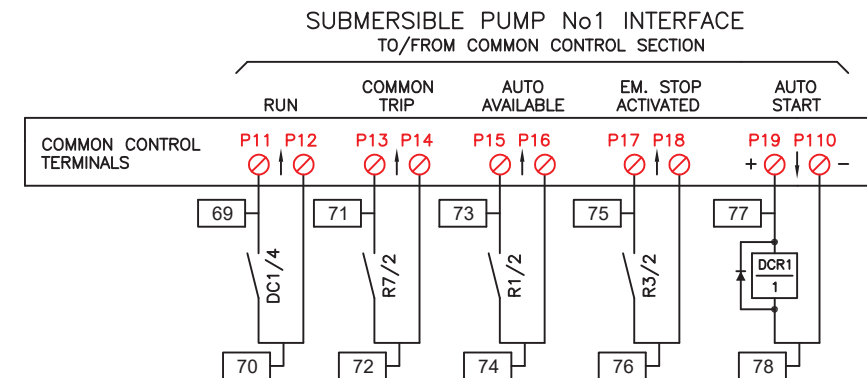
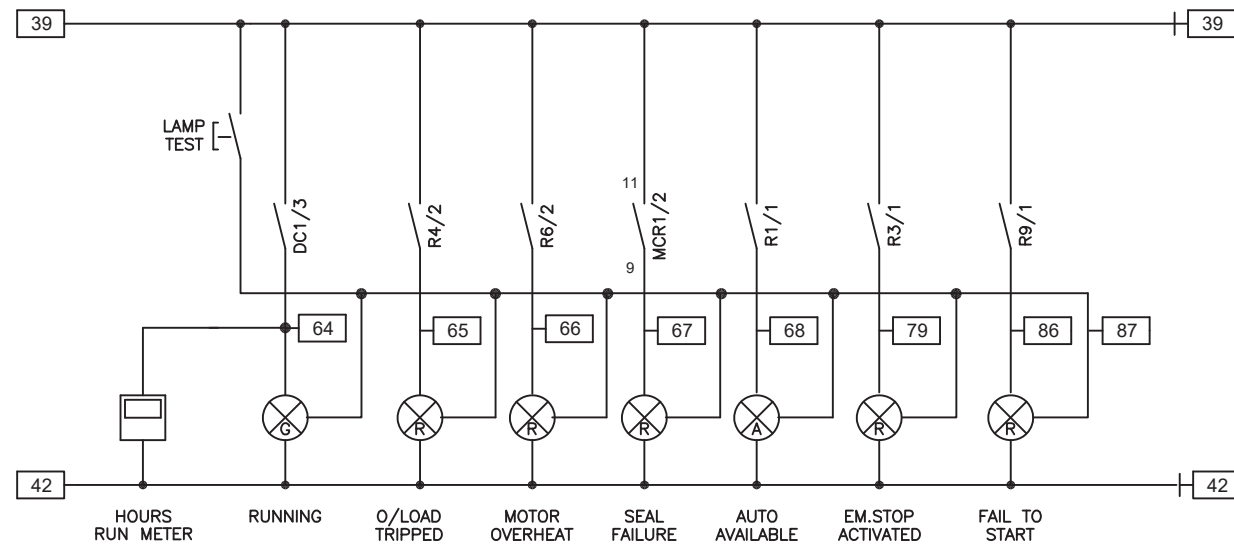
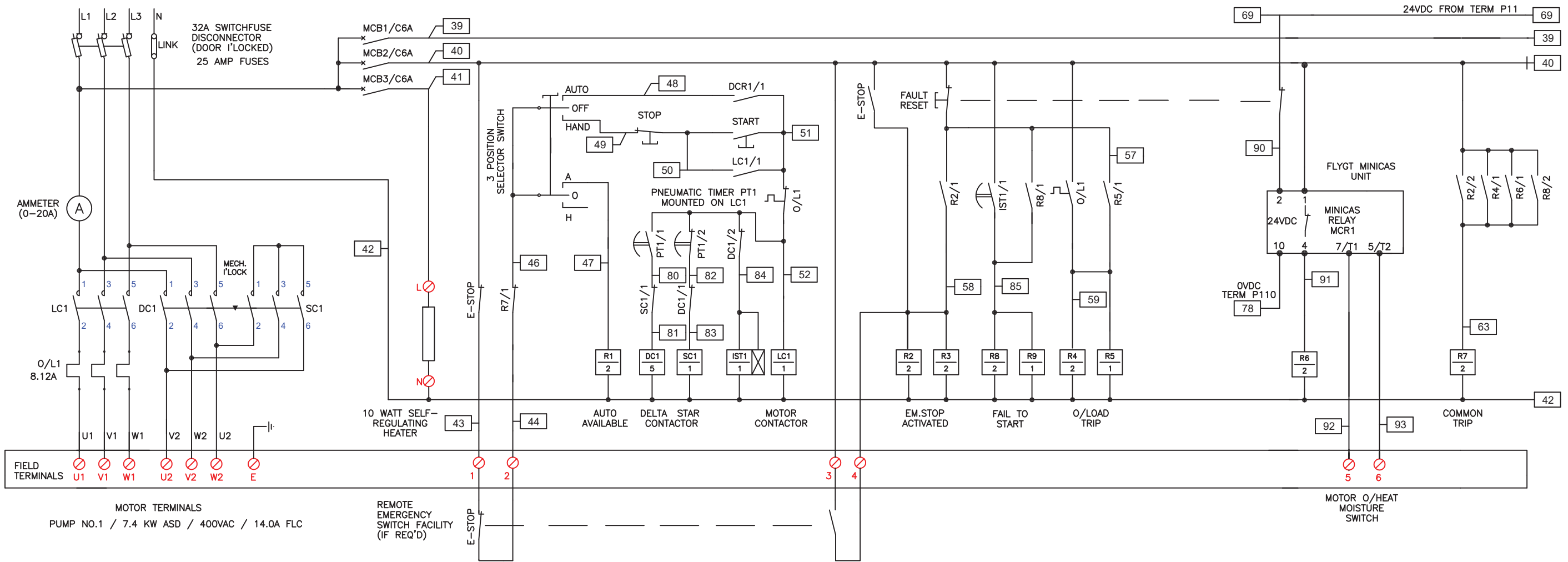



# PUMP XYLEM DOL

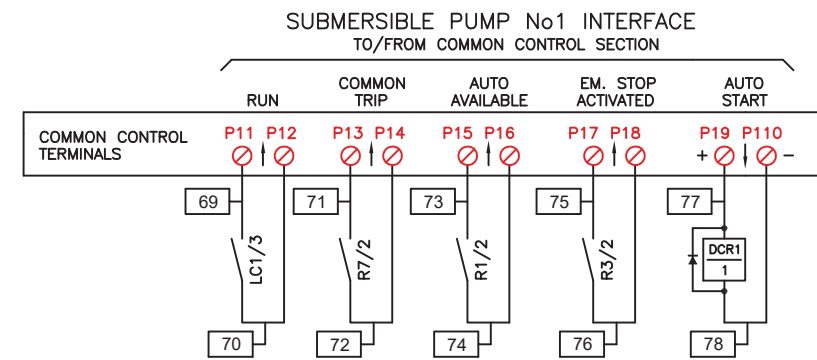
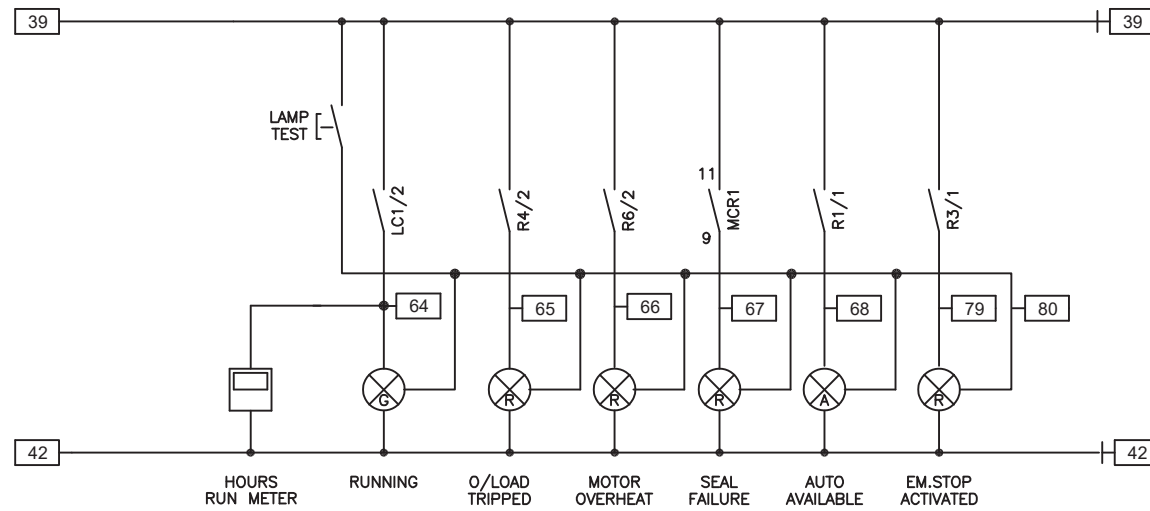
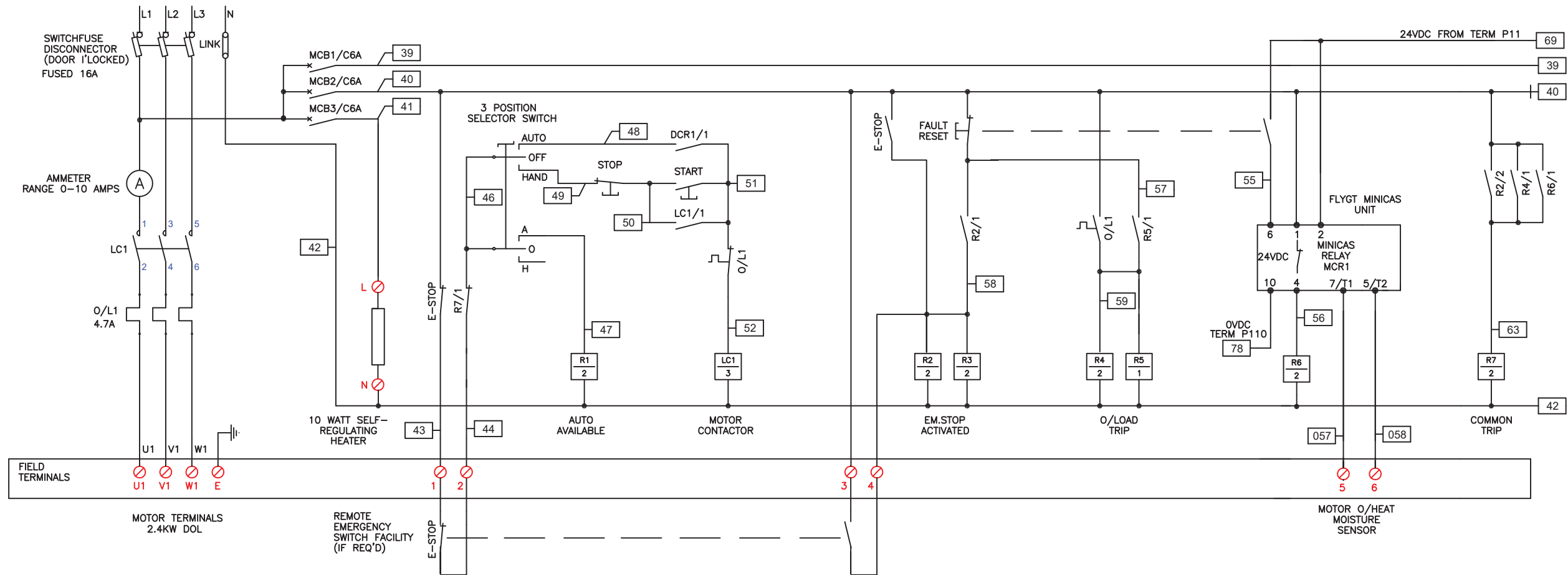

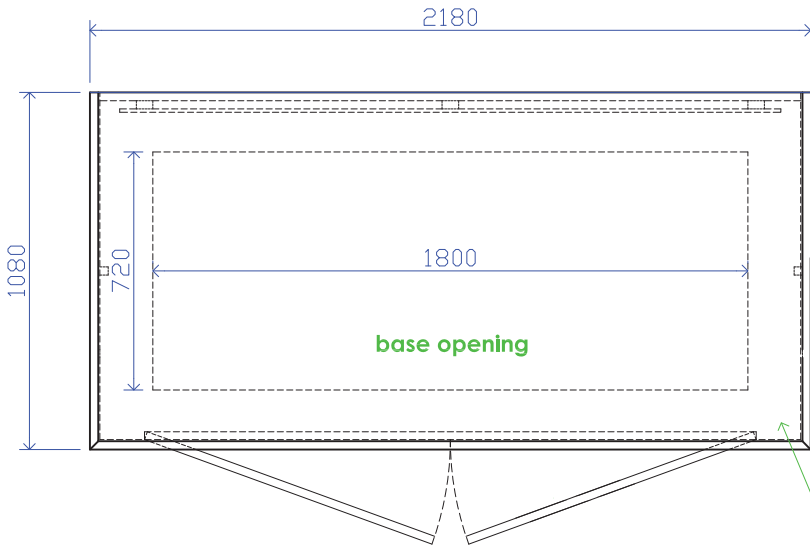
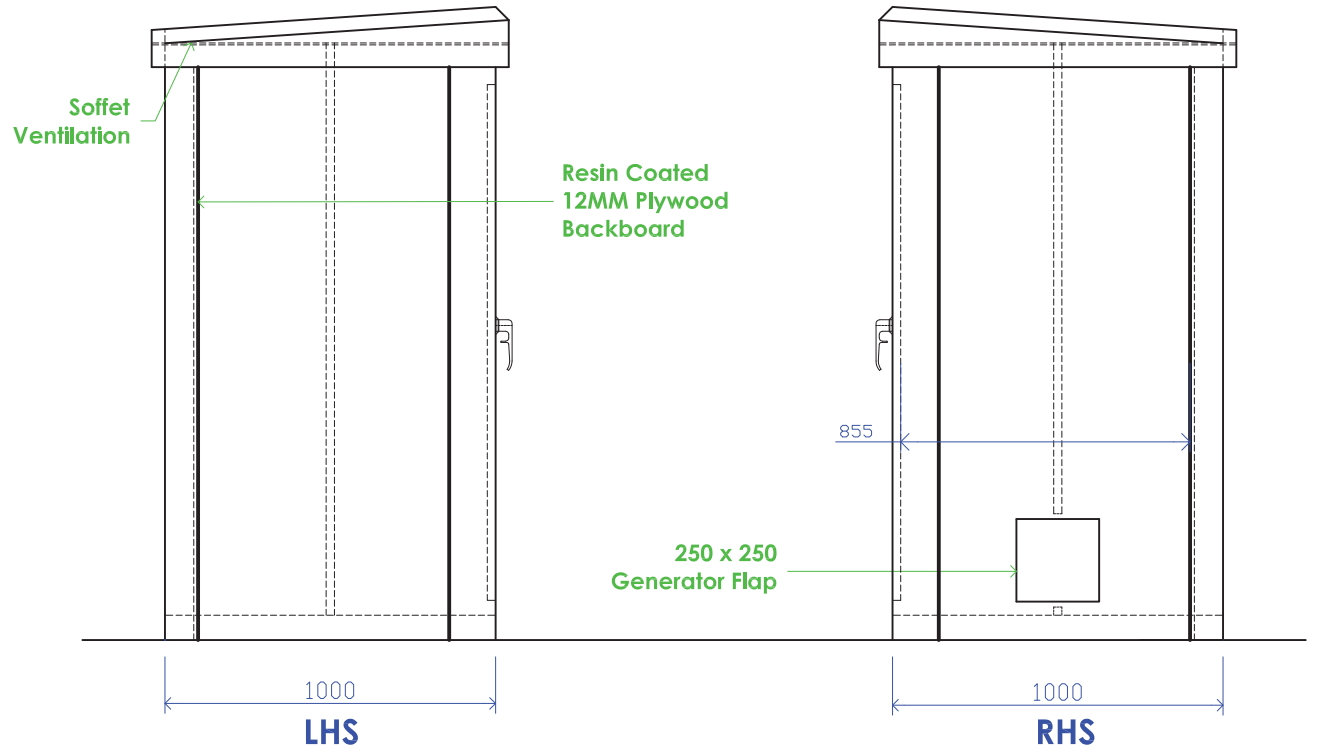
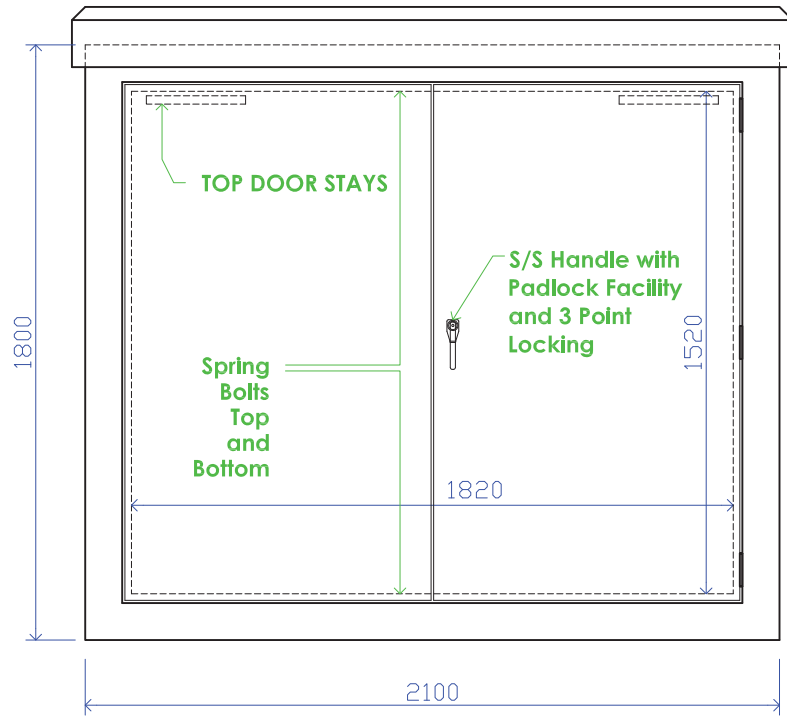

**PLAN**

# Pumping Station Kiosk Detail GRP 1000a